Plas Power Solar and Energy Storage Project

2.0.8 – 2.0.34 Indicative Sections and Elevations

February 2024

DNS Ref: DNS/3253253



Schedule of plans included in this document

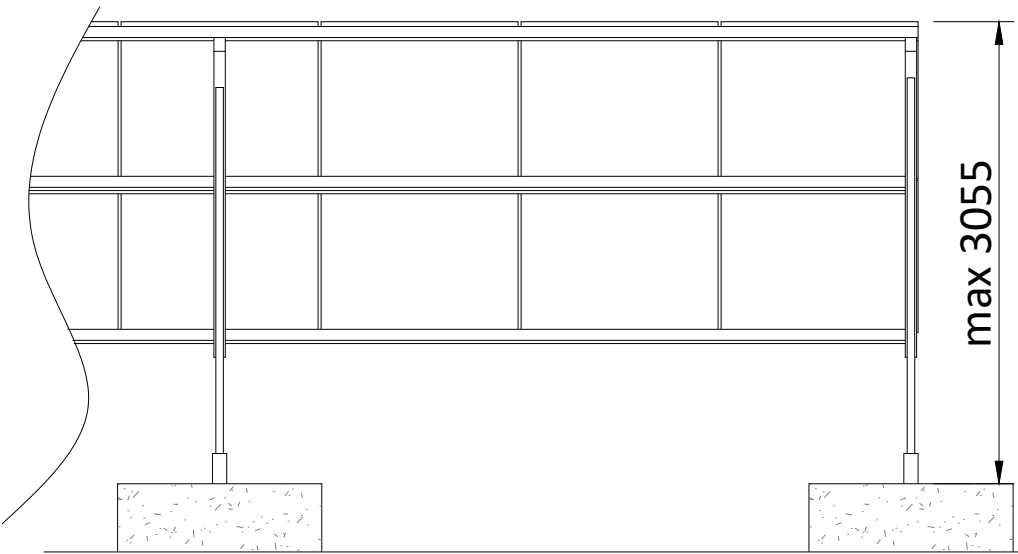
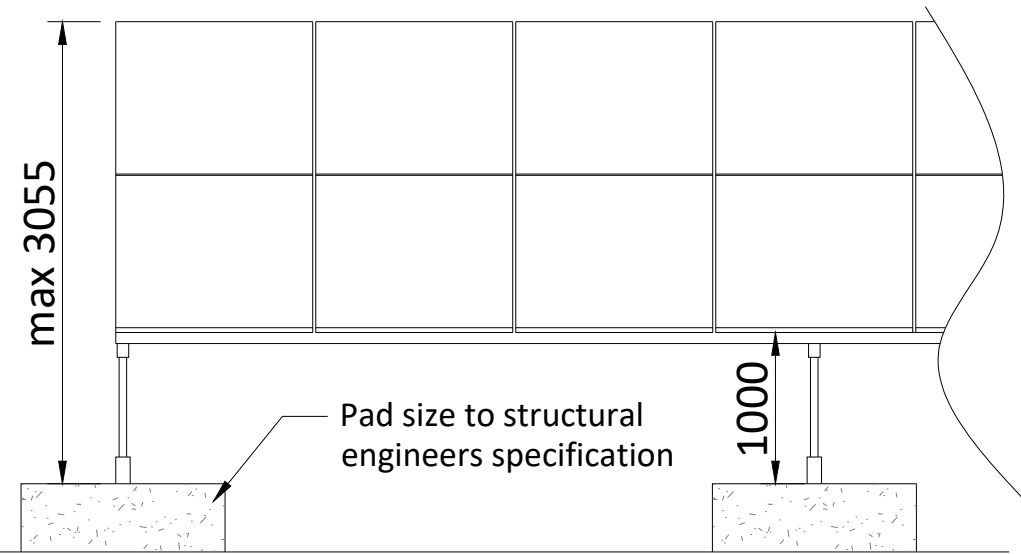
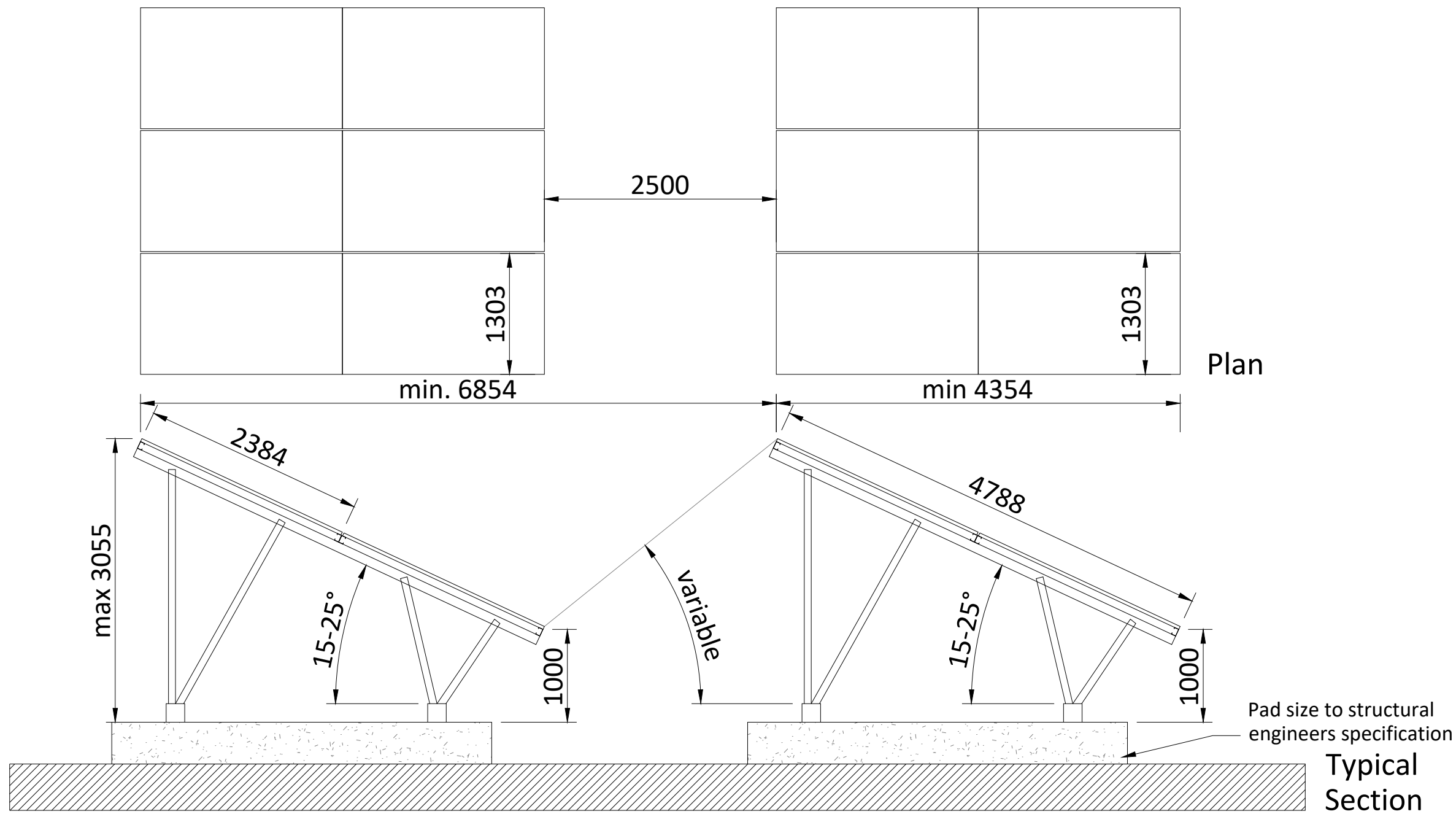

Document Ref	Document Title	Drawing Reference
2.0.8	Indicative Panel Elevation with Concrete Feet	FT-2P-25-6854-cf
2.0.9	Indicative Panel Elevation	FT-2P-25-6854
2.0.10	Inverters	GBR_EPD_INV
2.0.11	Transformers	GBR_EPD_TFM
2.0.12	Switchgear Substations	GBR_EPD_SWG
2.0.13	Auxiliary Transformer	GBR_EPD_AUX
2.0.14	PV Intake Substation	GBR_EPD_PVI
2.0.15	Customer Substation	GBR_EPD_CSS
2.0.16	GRP Substation	GBR_EPD_GRP
2.0.17	Monitoring House	GBR_EPD_MH/CB
2.0.18	Spares Container 40ft BESS Twin Battery Blocks	GBR_EPD_S40
2.0.19	Indicative BESS Layout	BESS_LYT
2.0.20	BESS Enclosures	K_EPD_BSS
2.0.21	BIC	GBR_EPD_BIC
2.0.22	Twin MV Skid	UK_EPD_TWS-NR
2.0.23	BESS Backup Generator	GBR_EPD_G20
2.0.24	BESS Spares Container 20ft	GBR_EPD_S20
2.0.25	BESS Intake Substation	GBR_EPD_BIS
2.0.26	BESS Security Fencing	GBR_EPD_BSF
2.0.27	BESS CCTV	GBR_EPD_BCC
2.0.28	BESS Gate	GBR_EPD_BSG
2.0.29	BESS Lighting Pole	GBR_EPD_BLG
2.0.30	Security Fencing	GBR_EPD_FNC

2.0.31	Gates	GBR_EPD_GTD
2.0.32	Solar CCTV	GBR_EPD_CTV
2.0.33	Composting Toilet	GBR_EPD_TLT
2.0.34	Indicative Road Cross Section	GBR_EPD_RCS



THIS DOCUMENT IS THE PROPERTY OF LIGHTSOURCE RENEWABLE DEVELOPMENT LTD
IT IS PROHIBITED TO REPRODUCE IT FOR OTHER PURPOSES WITHOUT AUTHORIZATION IN WRITING

GBR_Indicative EPD_FT-2P-25-6854-cf_01			
DA			Nov. 2023
DRAWN	CHECKED	APPROVED	DATE
Paper Size: A3	Scale: 1:50	Sheet: 1	
DRAWING NUMBER: FT-2P-25-6854-cf		STATUS: Rev 01	



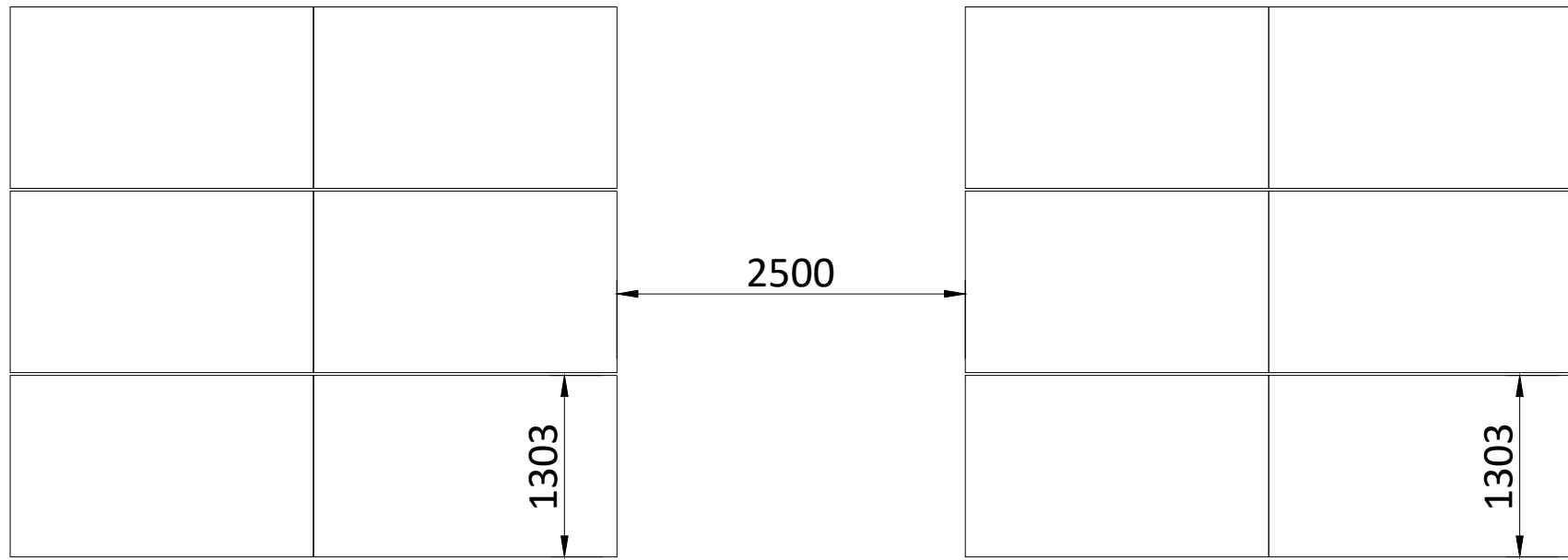

Lightsource Renewable Development Limited,
 7th Floor, 33 Holborn, London, EC1N 2HU
 General: +44 (0) 333 200 0755
 Web: www.lightsourcebp.com
 info@lightsourcebp.com

A3 - (420 x 297)mm

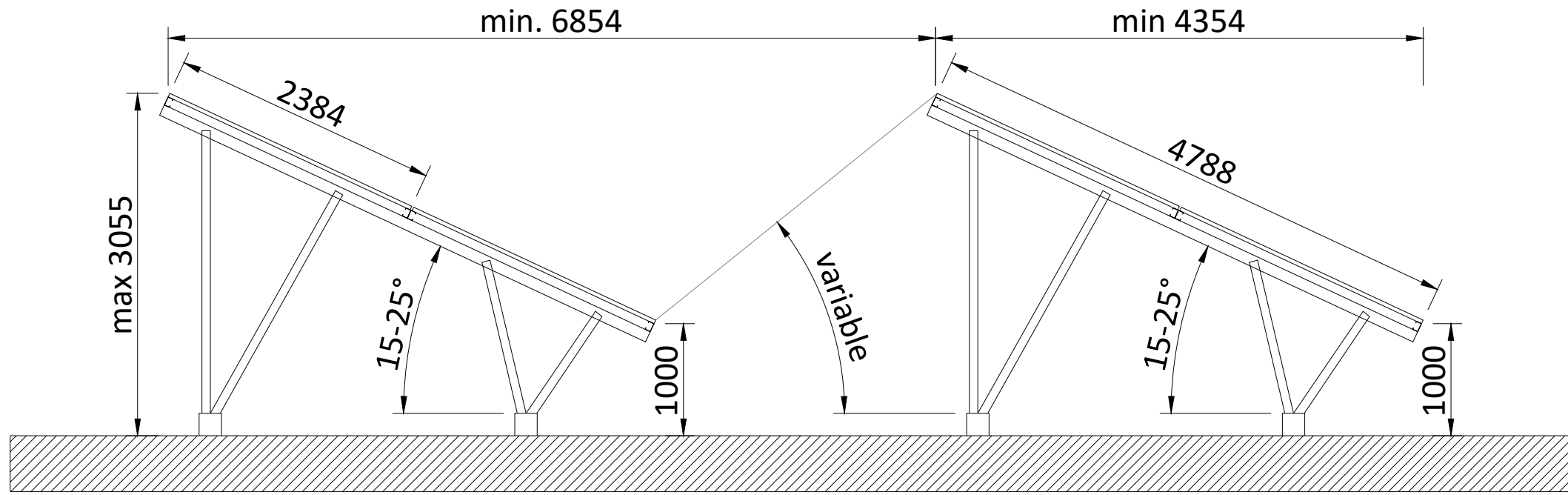

Plan



Typical Section

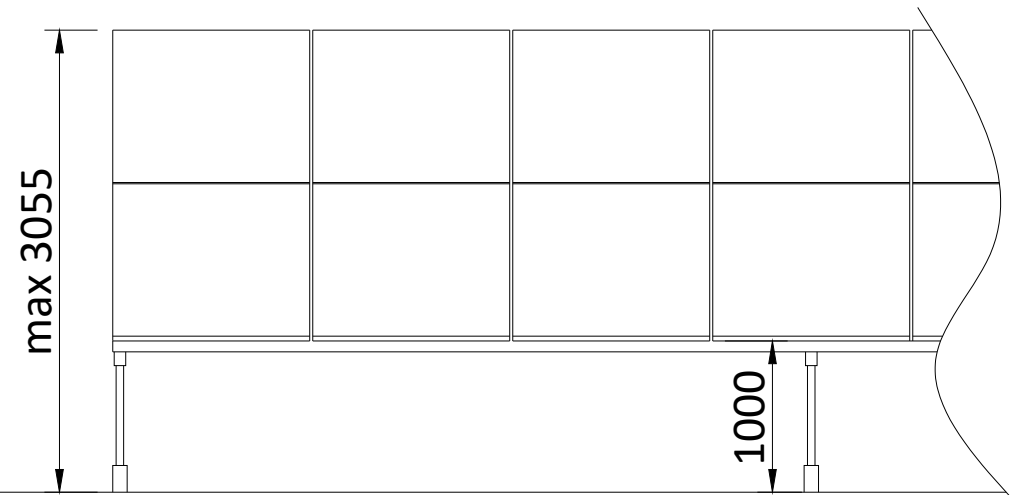

Typical Elevation

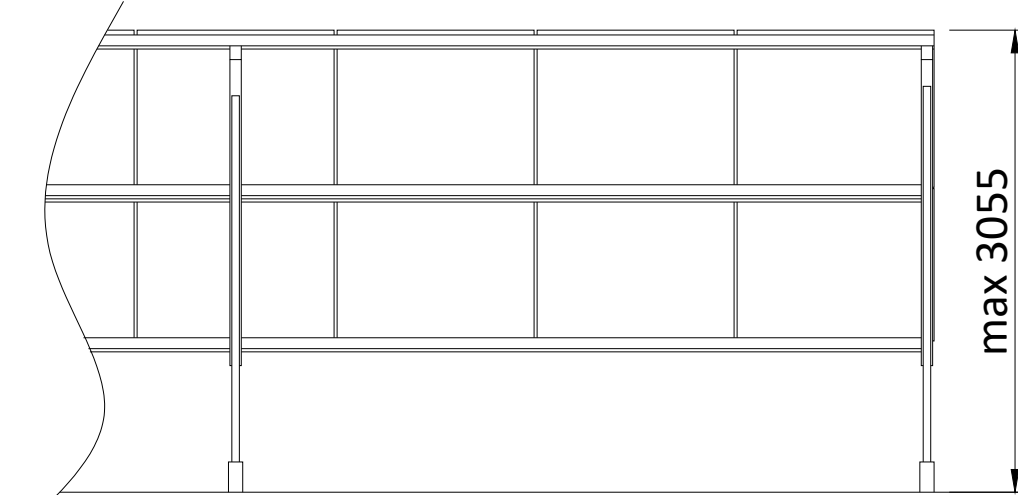

Typical Rear Elevation



THIS DOCUMENT IS THE PROPERTY OF LIGHTSOURCE RENEWABLE DEVELOPMENT LTD
IT IS PROHIBITED TO REPRODUCE IT FOR OTHER PURPOSES WITHOUT AUTHORIZATION IN WRITING

GBR_Indicative EPD_FT-2P-25-6854_00			
DA			Nov. 2023
DRAWN	CHECKED	APPROVED	DATE
Paper Size:	Scale:	Sheet:	
A3	1:50	1	
DRAWING NUMBER:		STATUS:	
FT-2P-25-6854		Rev 01	
Lightsource Renewable Development Limited, 7th Floor, 33 Holborn, London, EC1N 2HU General: +44 (0) 333 200 0755 Web: www.lightsourcebp.com info@lightsourcebp.com			

A3 - (420 x 297)mm

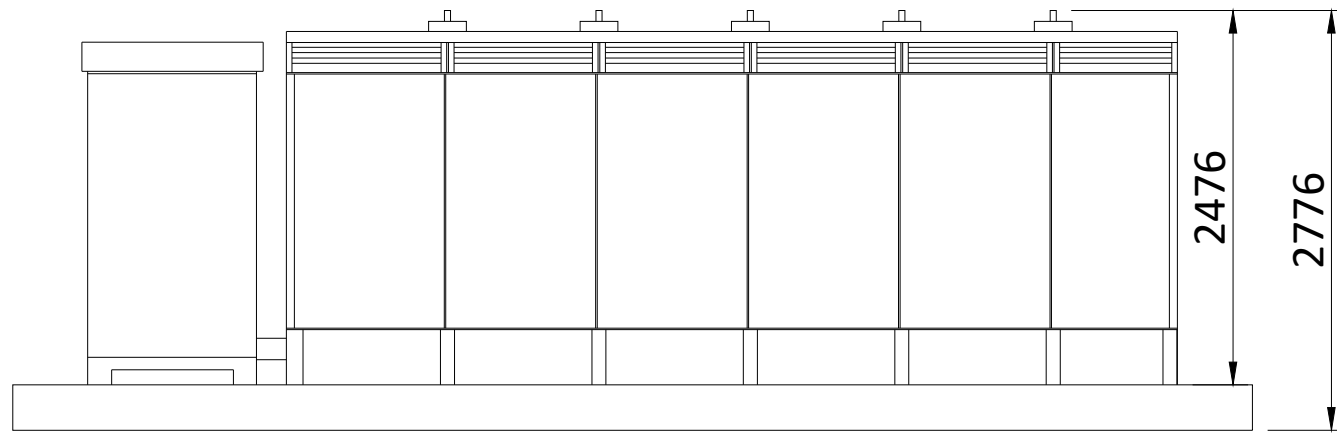

Front View

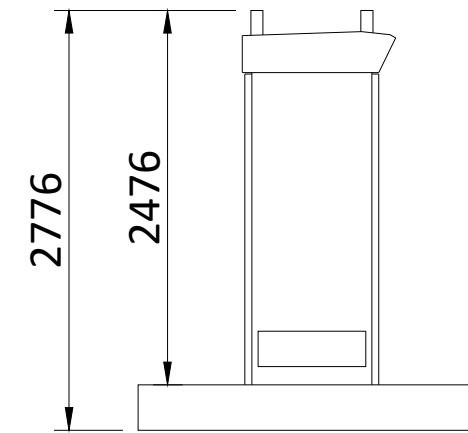

Side View

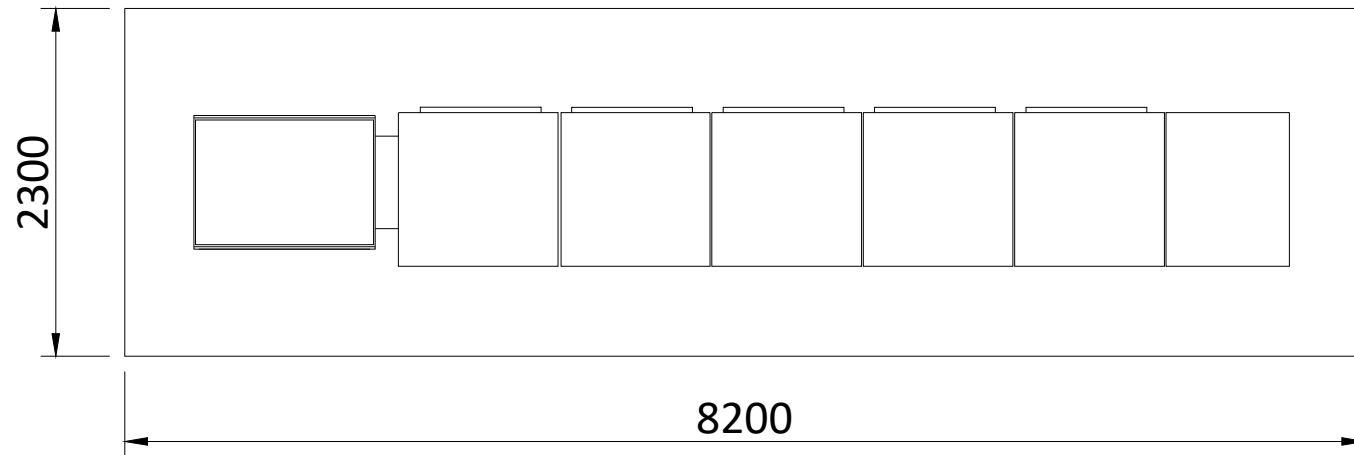

Plan View



THIS DOCUMENT IS THE PROPERTY OF LIGHTSOURCE RENEWABLE DEVELOPMENT LTD
IT IS PROHIBITED TO REPRODUCE IT FOR OTHER PURPOSES WITHOUT AUTHORIZATION IN WRITING

GBR_EPД_Inverter_01			
DA			Nov. 2023
DRAWN	CHECKED	APPROVED	DATE
Paper Size:	Scale:	Sheet:	
A3	1:50	1	
DRAWING NUMBER:		STATUS:	
GBR_EPД_INV		Rev 01	
Lightsource Renewable Development Limited, 7th Floor, 33 Holborn, London, EC1N 2HU General: +44 (0) 333 200 0755 Web: www.lightsourcebp.com info@lightsourcebp.com			

A3 - (420 x 297)mm

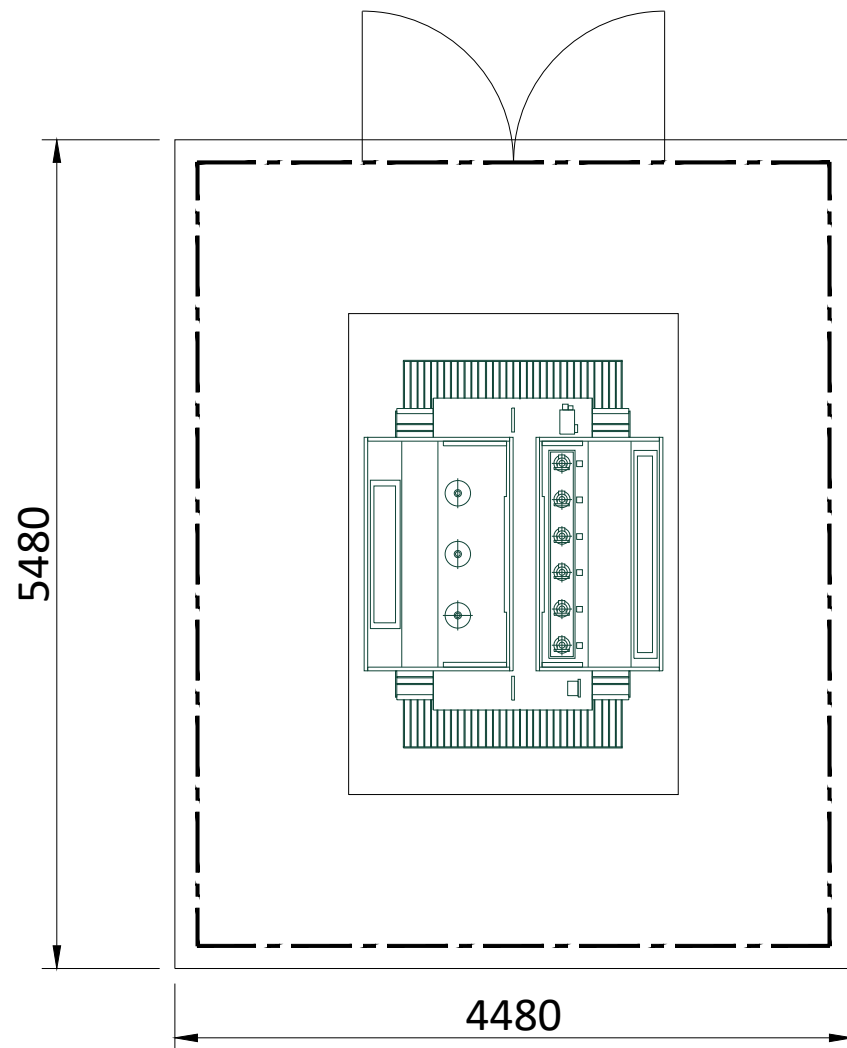
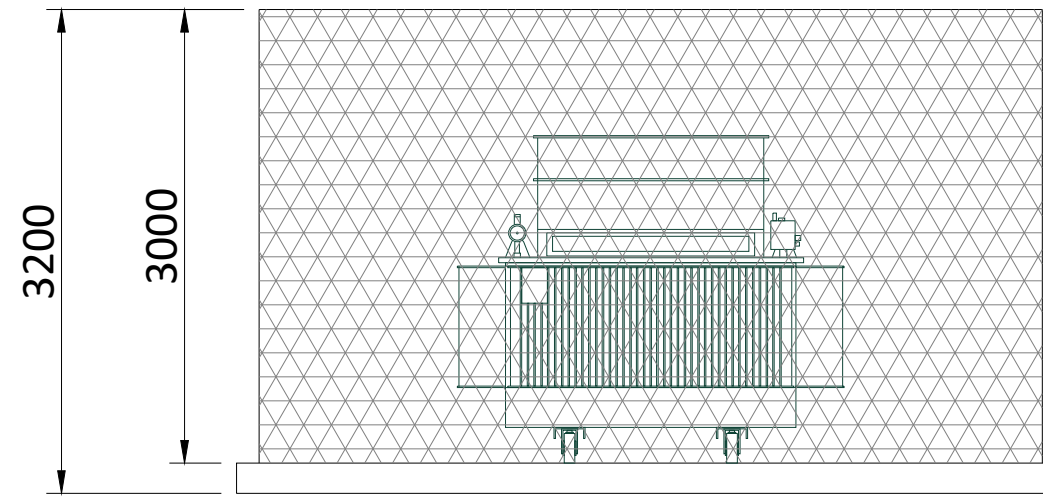
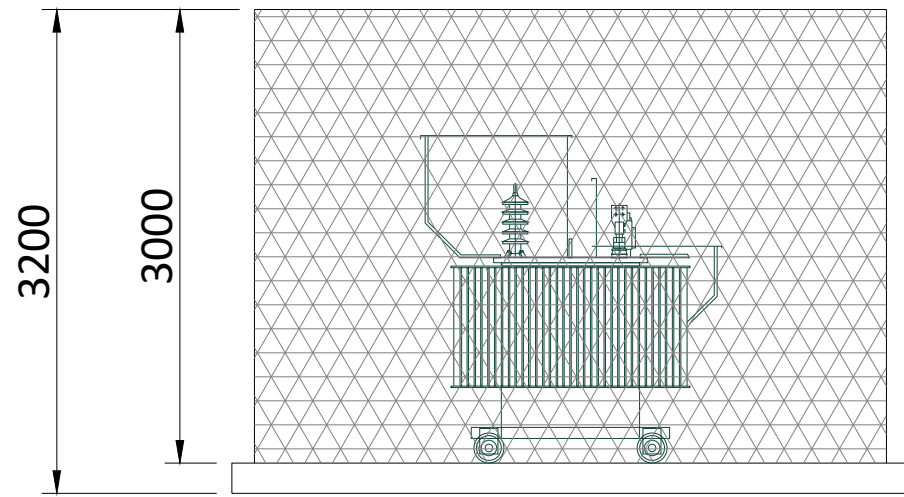

A3 - (420 x 297)mm

THIS DOCUMENT IS THE PROPERTY OF LIGHTSOURCE RENEWABLE DEVELOPMENT LTD
IT IS PROHIBITED TO REPRODUCE IT FOR OTHER PURPOSES WITHOUT AUTHORIZATION IN WRITING

GBR_EPД_Transformer_01			
DA			Nov. 2023
DRAWN	CHECKED	APPROVED	DATE
Paper Size:	Scale:	Sheet:	
A3	1:50	1	
DRAWING NUMBER:		STATUS:	
GBR_EPД_TFM		Rev 01	
Lightsource Renewable Development Limited, 7th Floor, 33 Holborn, London, EC1N 2HU General: +44 (0) 333 200 0755 Web: www.lightsourcebp.com info@lightsourcebp.com			

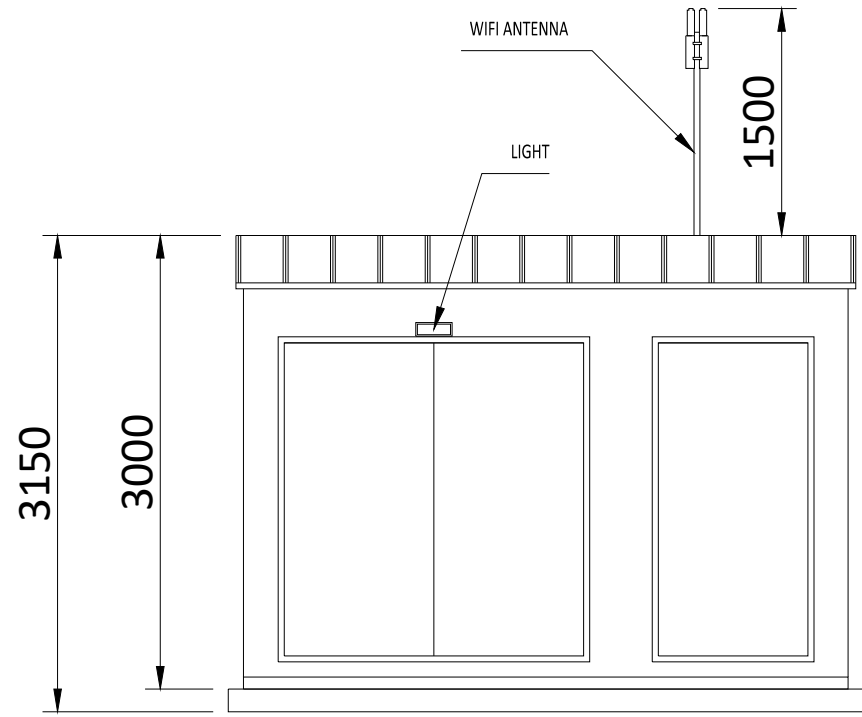

Front View

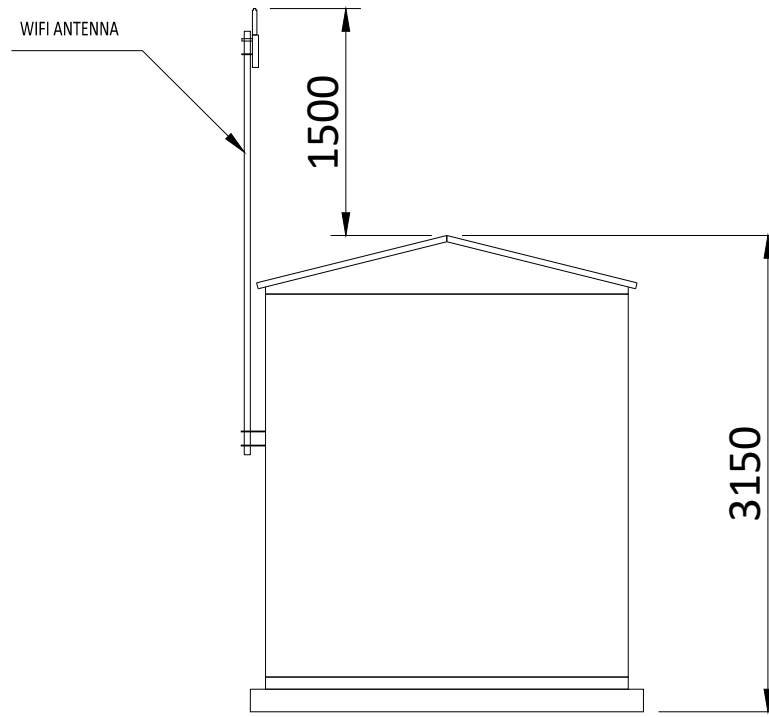

Side View

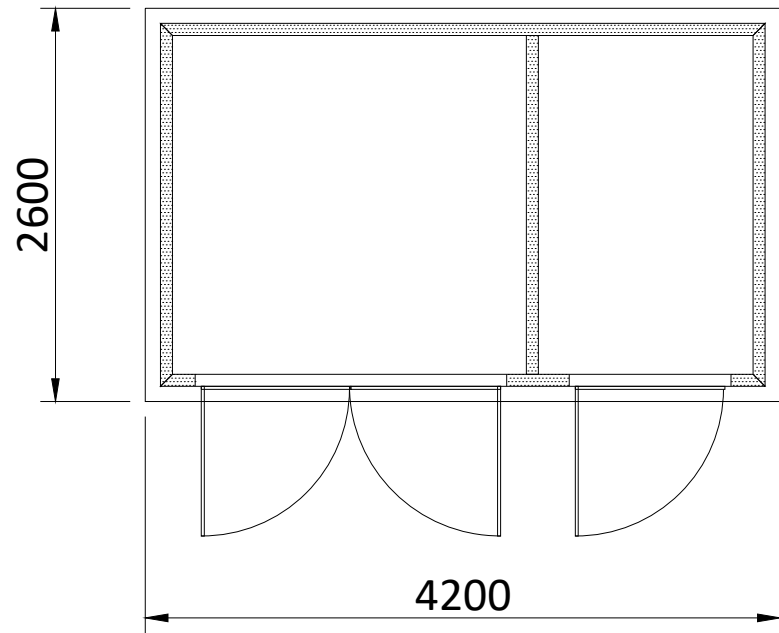



Plan View



A3 - (420 x 297)mm

THIS DOCUMENT IS THE PROPERTY OF LIGHTSOURCE RENEWABLE DEVELOPMENT LTD
IT IS PROHIBITED TO REPRODUCE IT FOR OTHER PURPOSES WITHOUT AUTHORIZATION IN WRITING

GBR_EPD_Switchgear/Production Substation/LV&MV Kiosk_01			
DA			Nov. 2023
DRAWN	CHECKED	APPROVED	DATE
Paper Size: A3	Scale: 1:50	Sheet: 1	
DRAWING NUMBER: GBR_EPD_SWG		STATUS: Rev 01	

Lightsource Renewable Development Limited,
 7th Floor, 33 Holborn, London, EC1N 2HU
 General: +44 (0) 333 200 0755
 Web: www.lightsourcebp.com
 info@lightsourcebp.com

GBR_EPDAuxiliary Transformer_01

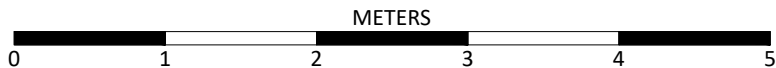
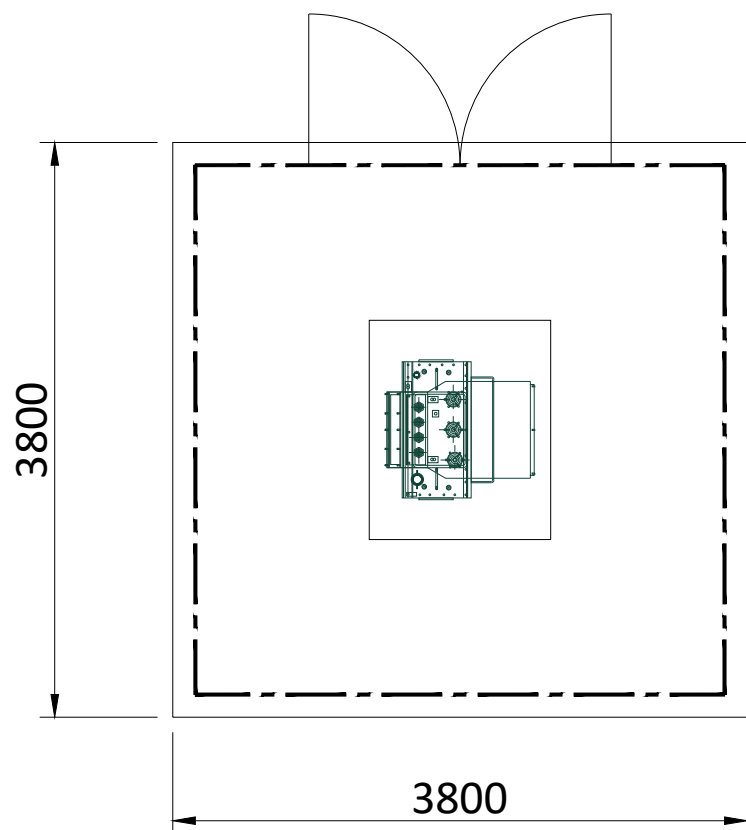
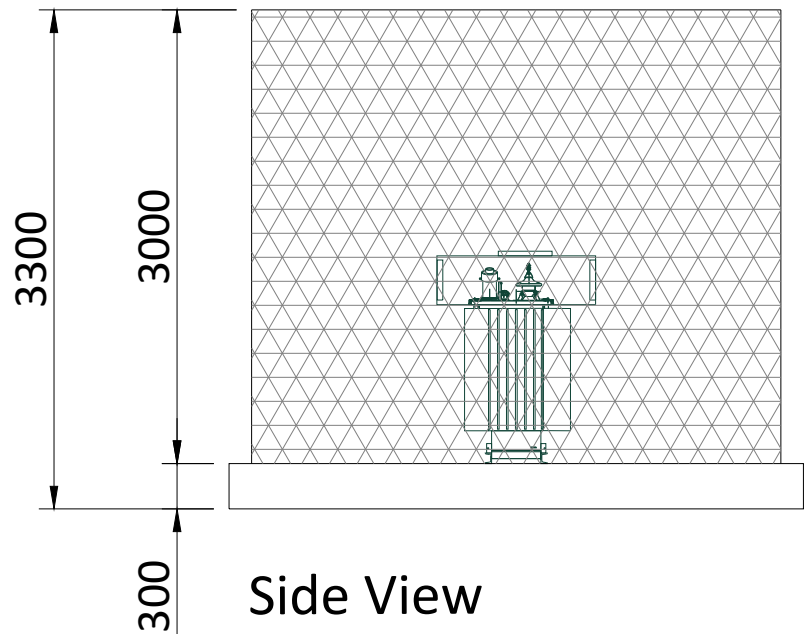
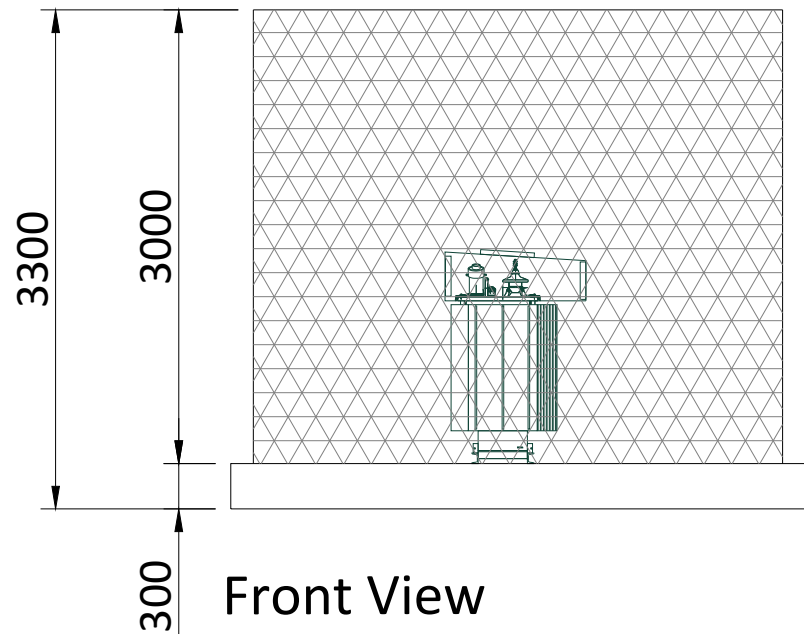

A3 - (420 x 297)mm

THIS DOCUMENT IS THE PROPERTY OF LIGHTSOURCE RENEWABLE ENERGY HOLDINGS LTD
IT IS PROHIBITED TO REPRODUCE IT FOR OTHER PURPOSES WITHOUT AUTHORIZATION IN WRITING

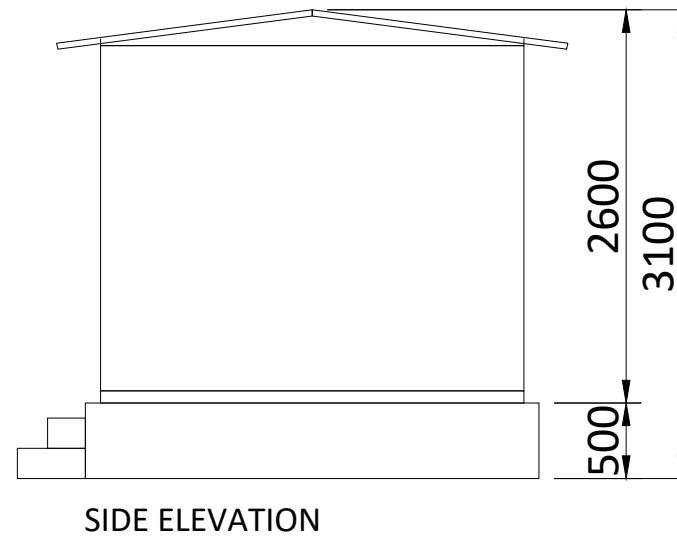
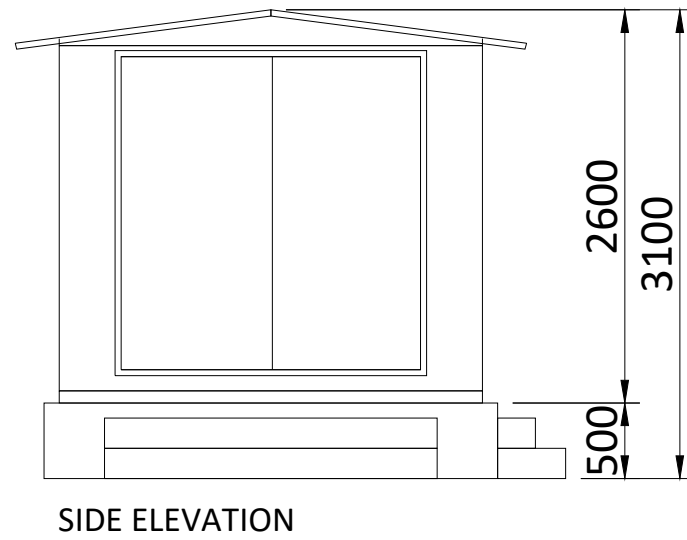
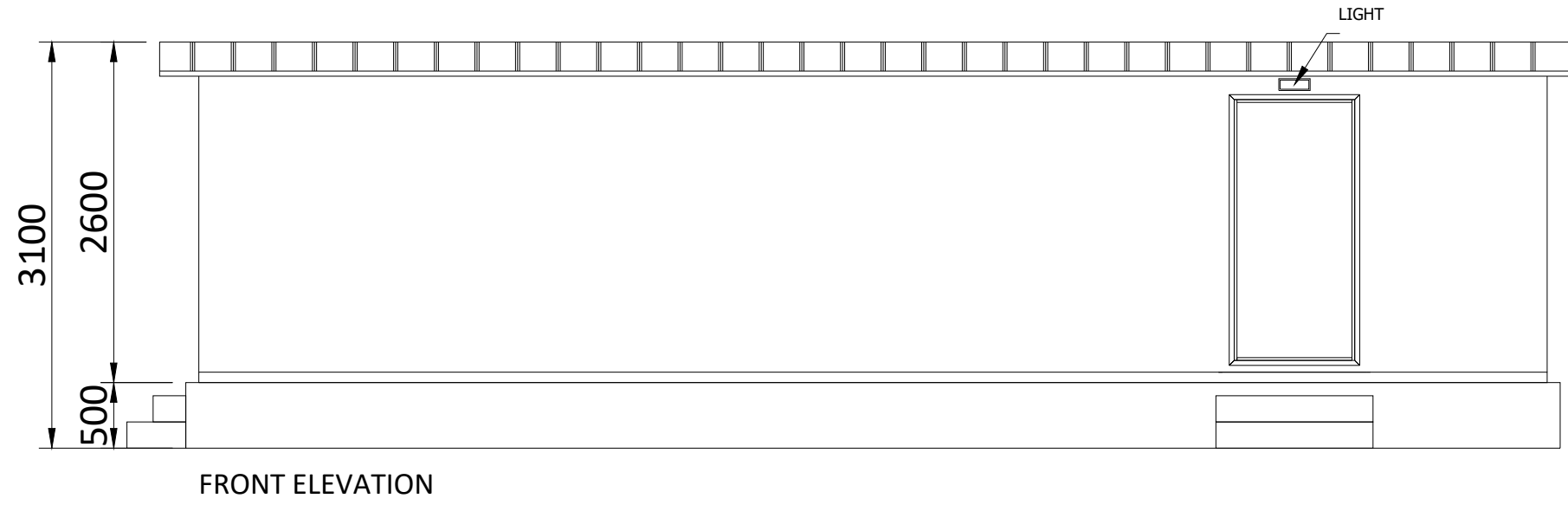
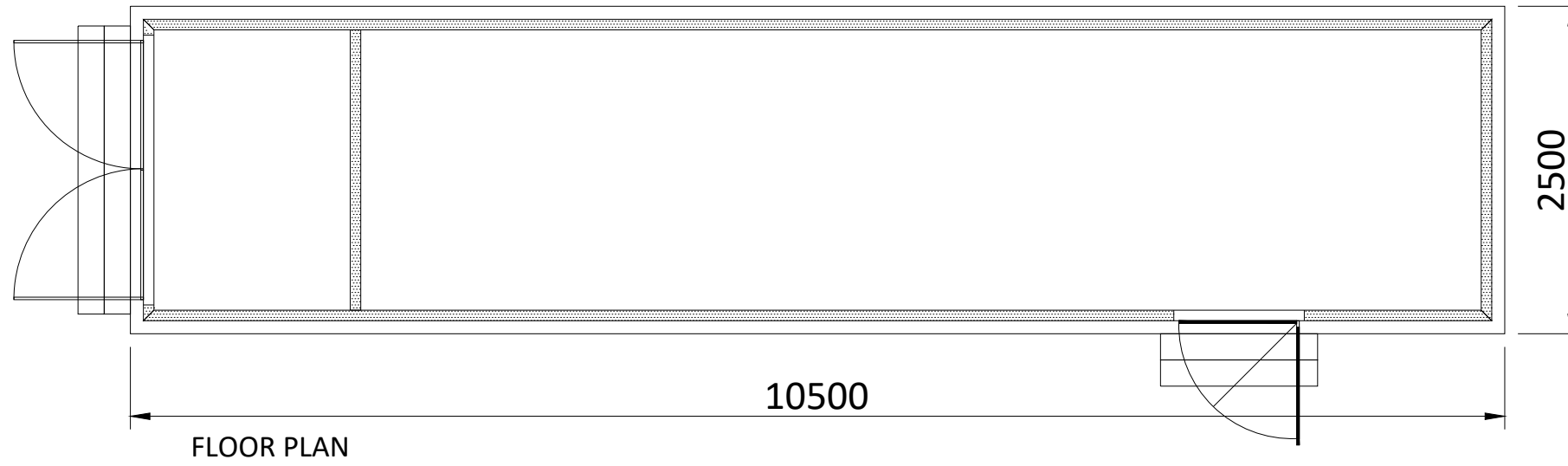

GBR_EPDAuxiliary Transformer_01			
DA			Nov. 2023
DRAWN	CHECKED	APPROVED	DATE
Paper Size: A3	Scale: 1:50	Sheet: 1	
DRAWING NUMBER: GBR_EPDAUX		STATUS: Rev 01	
 			
Lightsource Renewable Energy Holdings Limited, 7th Floor, 33 Holborn, London, EC1N 2HU General: +44 (0) 333 200 0755 Web: www.lightsource-re.co.uk info@lightsource-re.co.uk			

GBR_EPД_PV Intake Substation_00



THIS DOCUMENT IS THE PROPERTY OF LIGHTSOURCE RENEWABLE DEVELOPMENT LTD
IT IS PROHIBITED TO REPRODUCE IT FOR OTHER PURPOSES WITHOUT AUTHORIZATION IN WRITING

GBR_EPД_PV Intake Substation_00			
DA			Nov. 2023
DRAWN	CHECKED	APPROVED	DATE
Paper Size: A3	Scale: 1:50	Sheet: 1	
DRAWING NUMBER: GBR_EPД_PVI		STATUS: Rev 01	



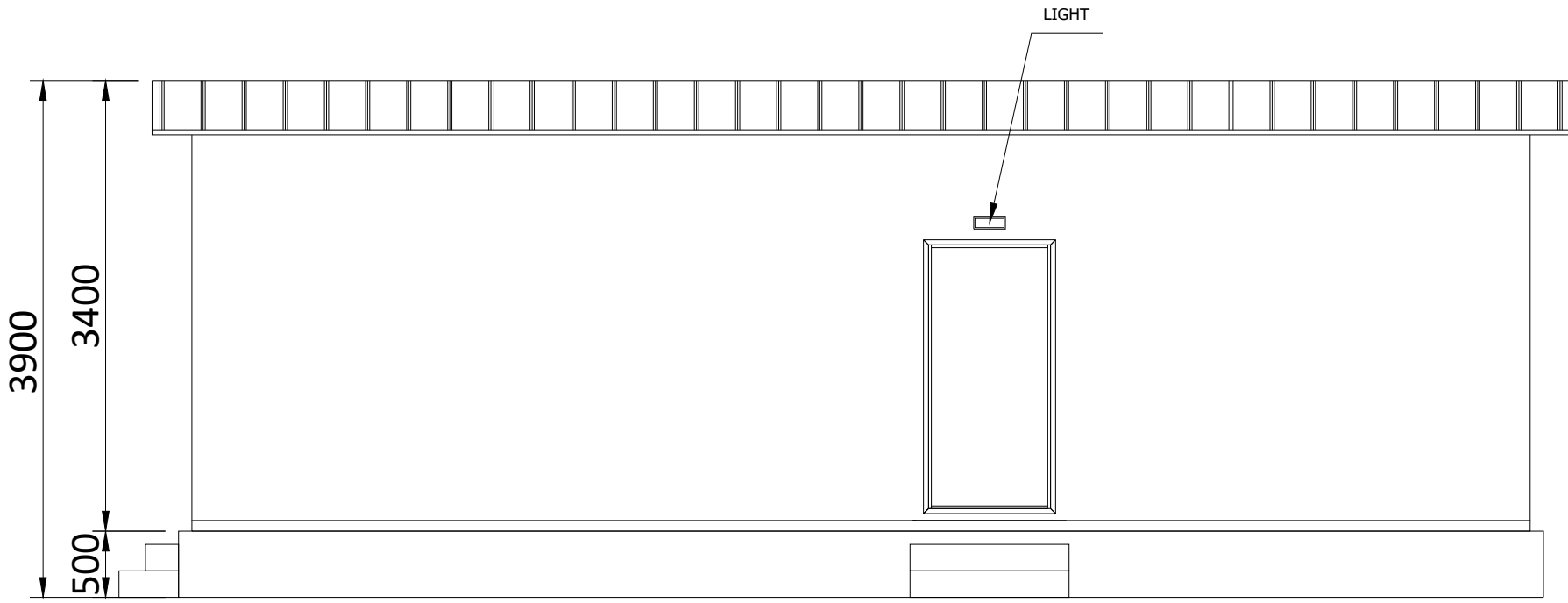

Lightsource Renewable Development Limited,
 7th Floor, 33 Holborn, London, EC1N 2HU
 General: +44 (0) 333 200 0755
 Web: www.lightsourcebp.com
 info@lightsourcebp.com

A3 - (420 x 297)mm

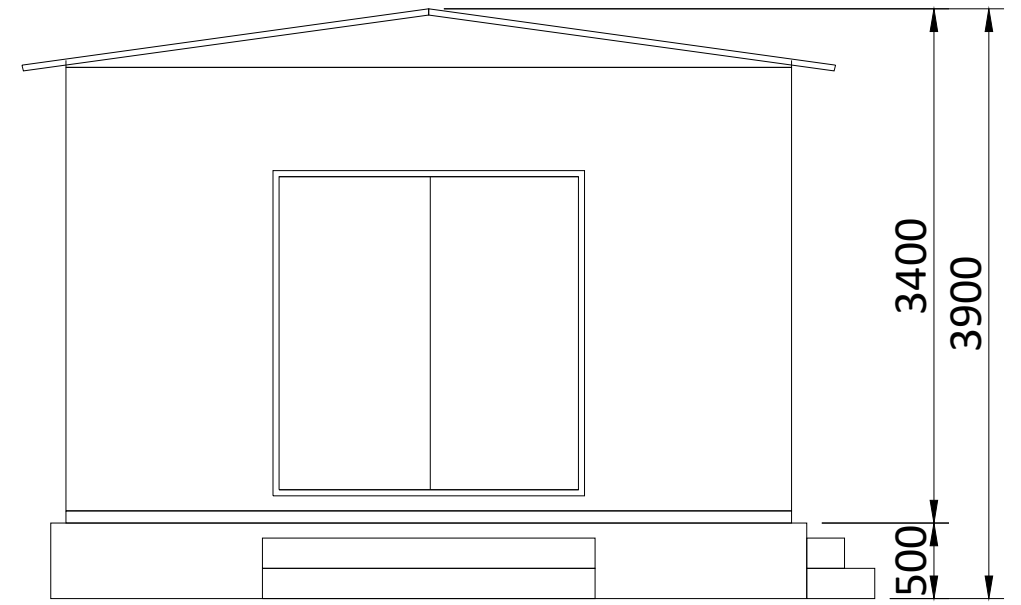

FRONT ELEVATION



SIDE ELEVATION

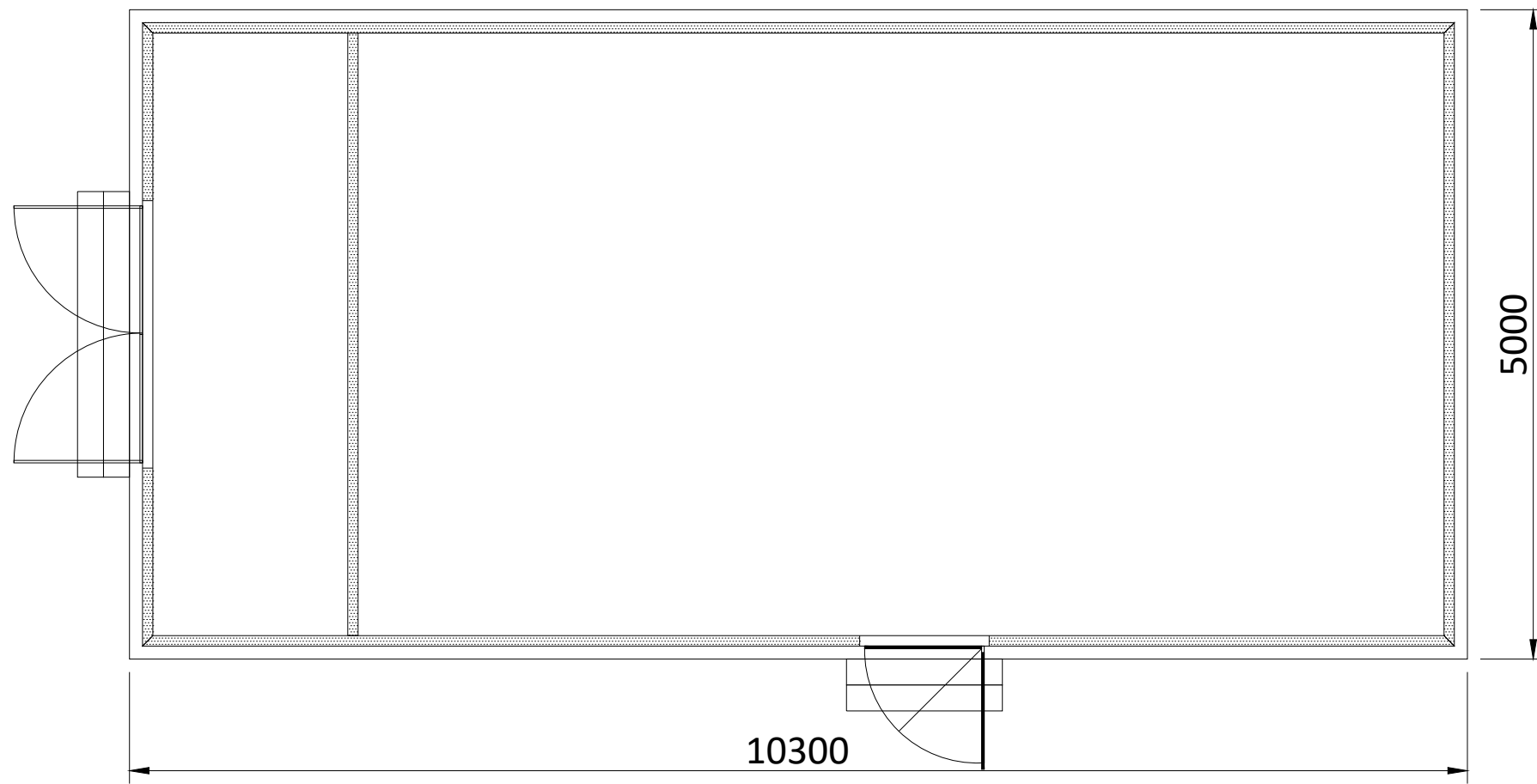

FLOOR PLAN

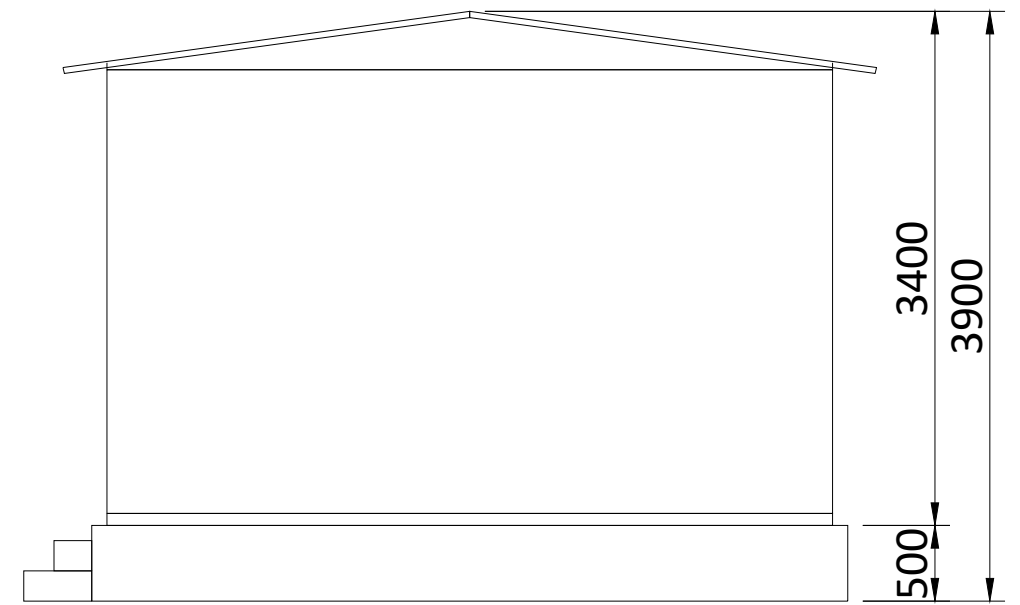



SIDE ELEVATION



METERS

THIS DOCUMENT IS THE PROPERTY OF LIGHTSOURCE RENEWABLE DEVELOPMENT LTD
IT IS PROHIBITED TO REPRODUCE IT FOR OTHER PURPOSES WITHOUT AUTHORIZATION IN WRITING

GBR_EPД_Customer Substation_00			
DA			Nov. 2023
DRAWN	CHECKED	APPROVED	DATE
Paper Size: A3	Scale: 1:50	Sheet: 1	
DRAWING NUMBER: GBR_EPД_CSS		STATUS: Rev 01	

Lightsource Renewable Development Limited,
 7th Floor, 33 Holborn, London, EC1N 2HU
 General: +44 (0) 333 200 0755
 Web: www.lightsourcebp.com
 info@lightsourcebp.com

A3 - (420 x 297)mm

GRB_EPD_GRP_00

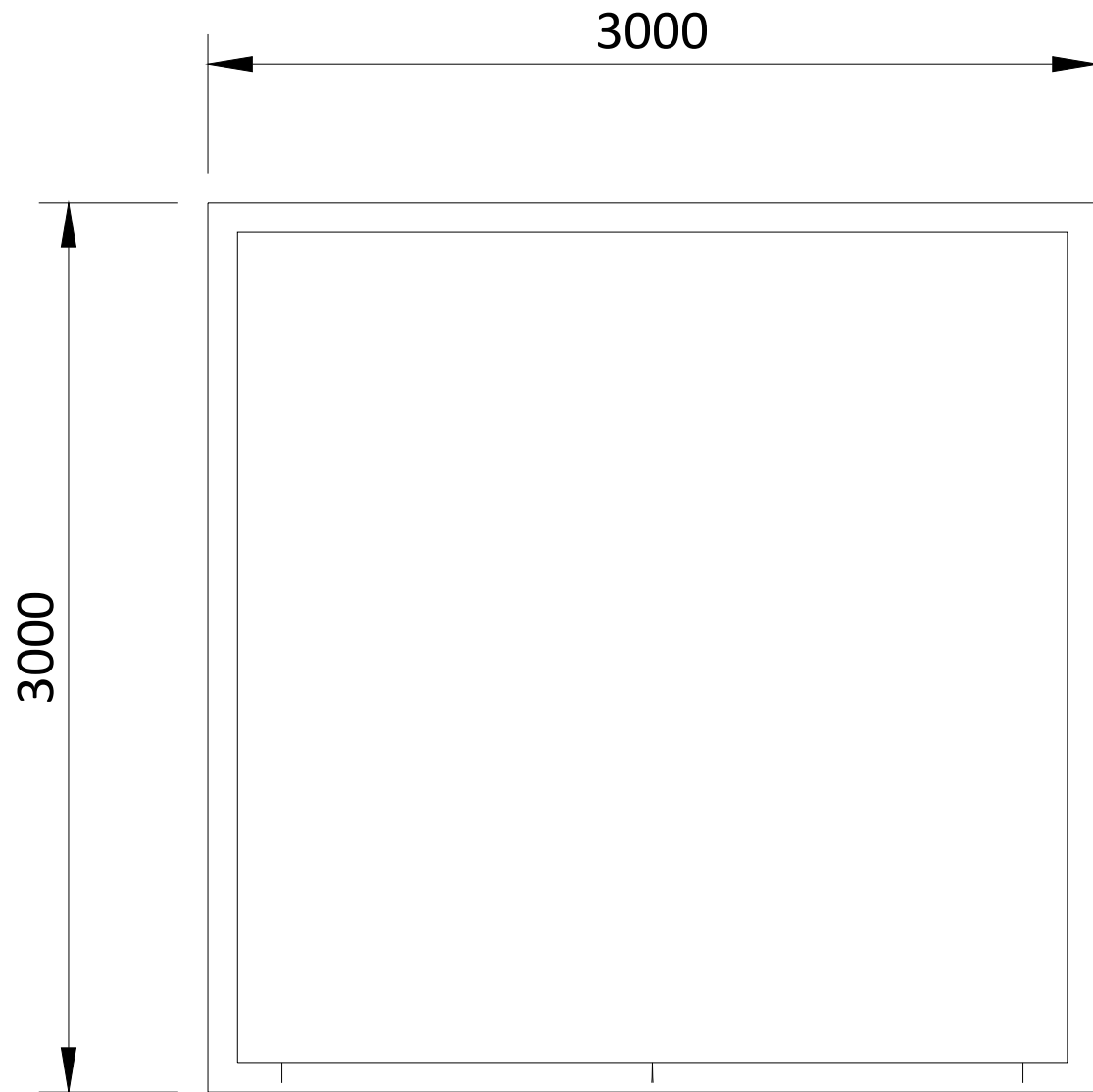

FLOOR PLAN

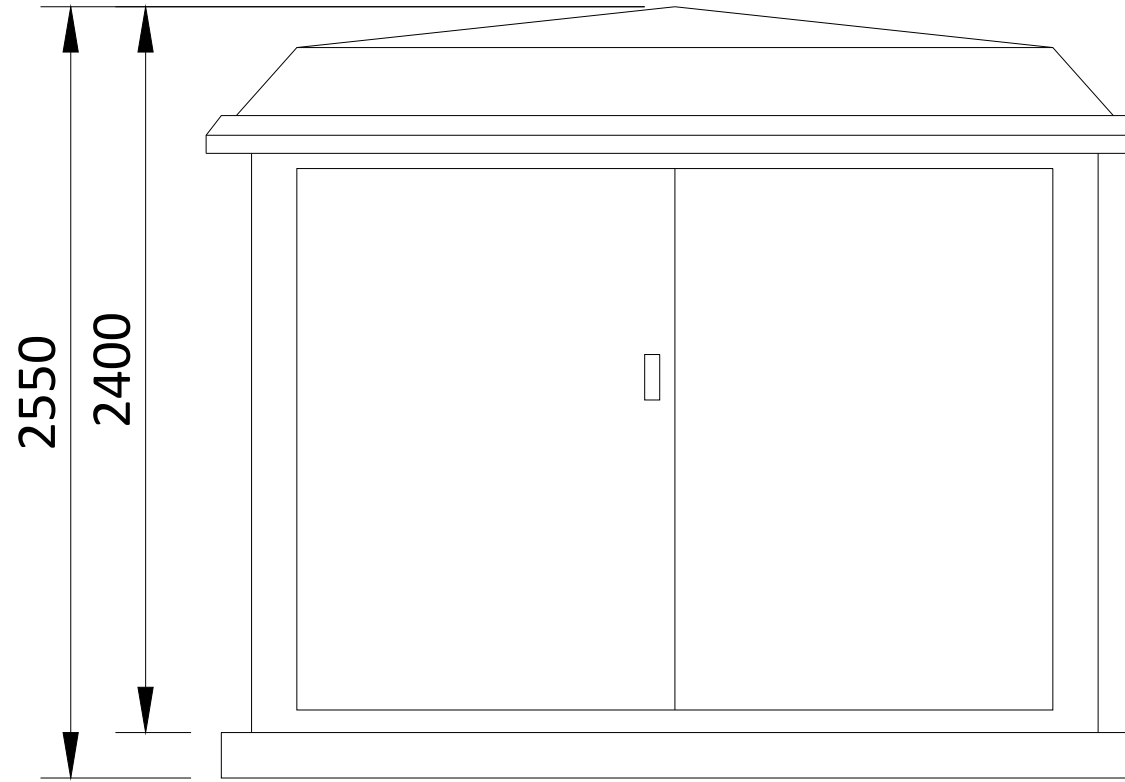

FRONT ELEVATION

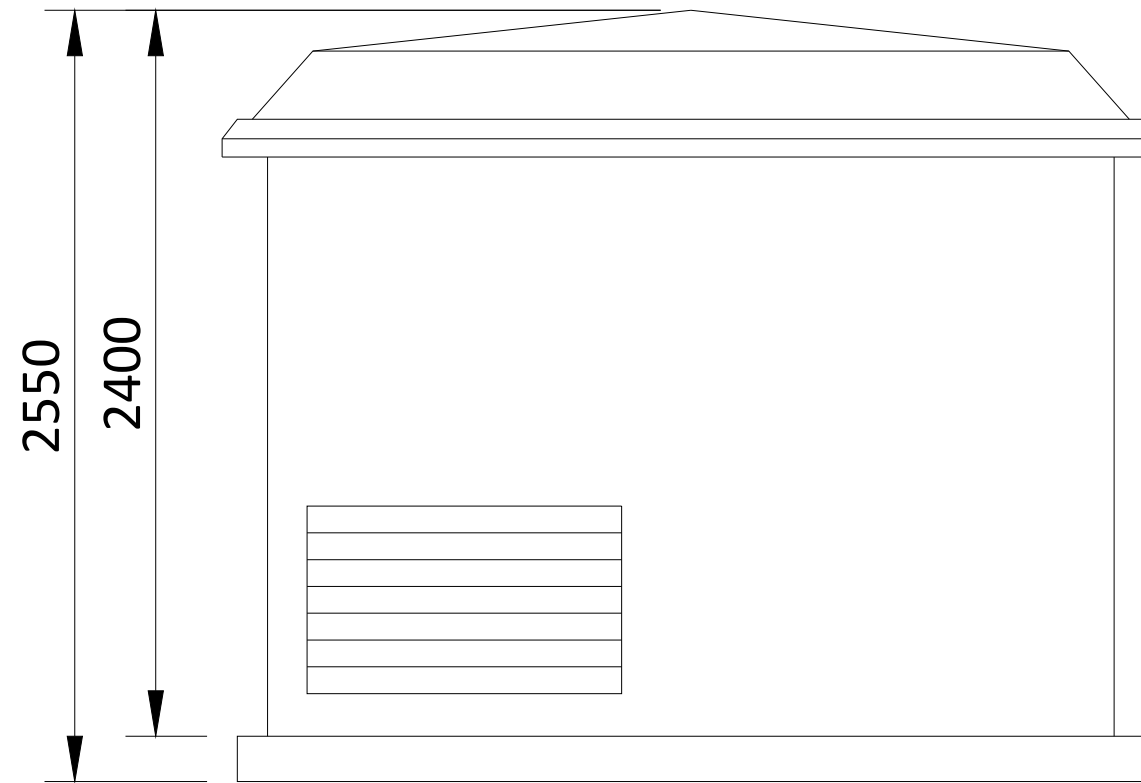

SIDE ELEVATION

METERS



A3 - (420 x 297)mm

THIS DOCUMENT IS THE PROPERTY OF LIGHTSOURCE RENEWABLE DEVELOPMENT LTD
IT IS PROHIBITED TO REPRODUCE IT FOR OTHER PURPOSES WITHOUT AUTHORIZATION IN WRITING

GBR_EPD_GRP_00			
DA			Nov. 2023
DRAWN	CHECKED	APPROVED	DATE
Paper Size: A3	Scale: 1:25	Sheet: 1	
DRAWING NUMBER: GBR_EPD_GRP		STATUS: Rev 01	

lightsourcebp 

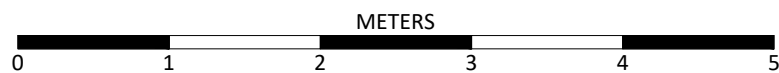
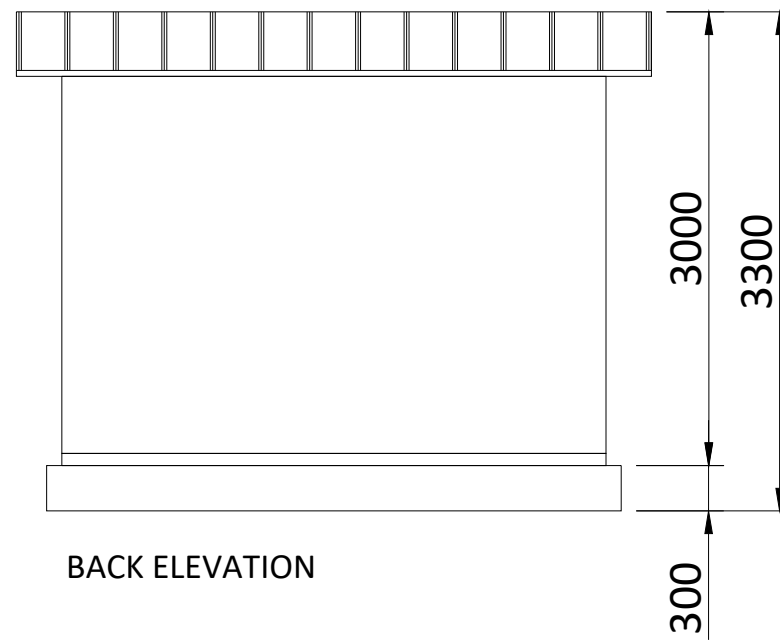
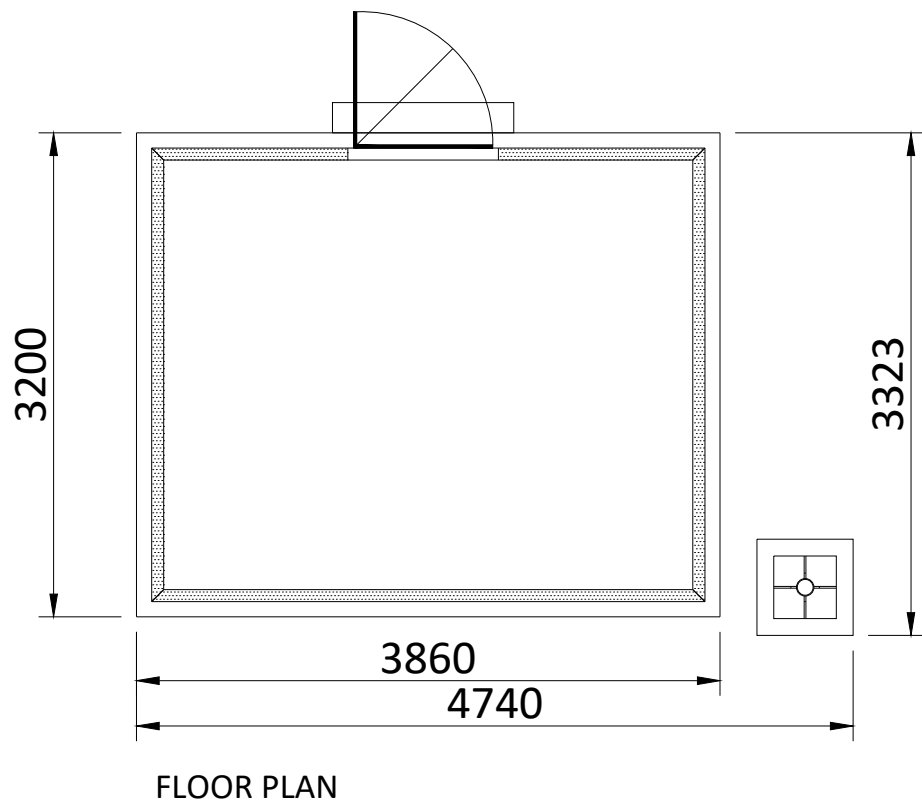
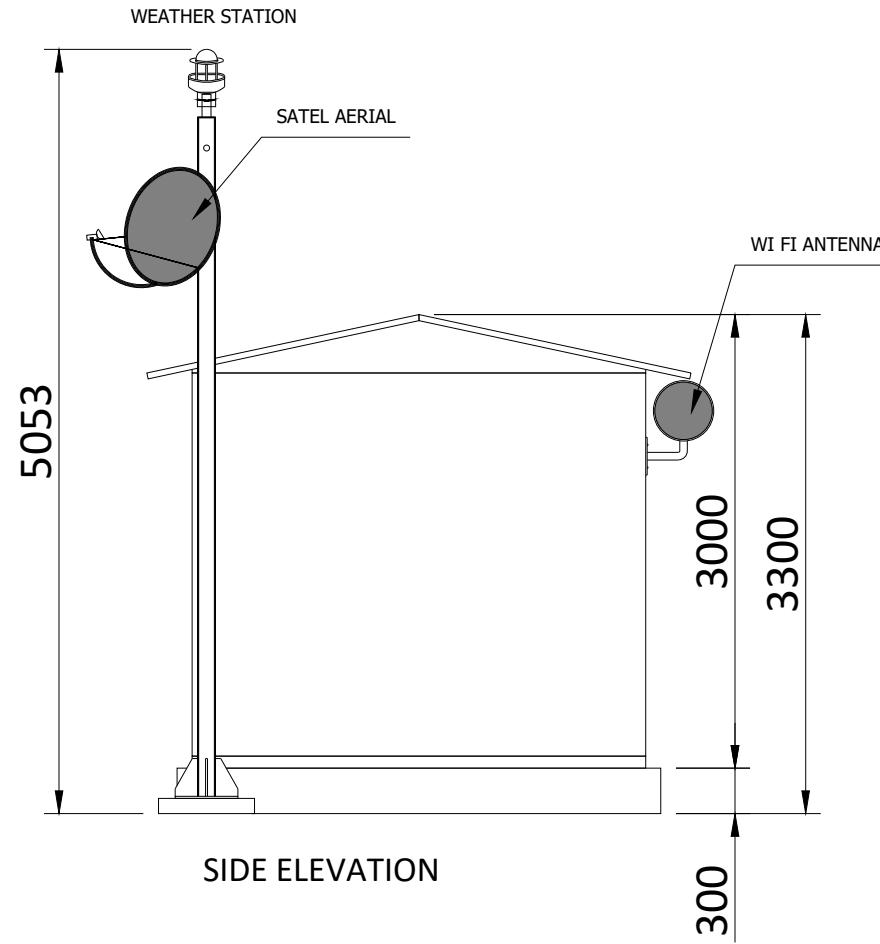
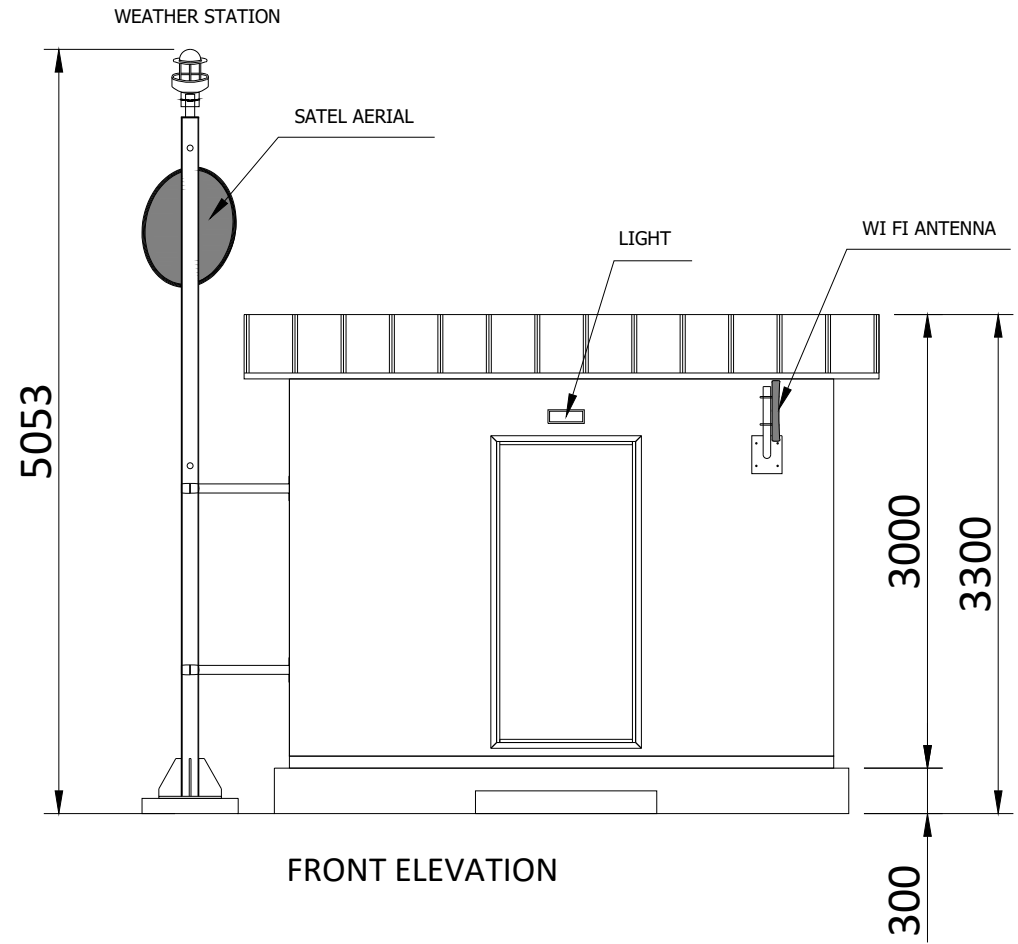

Lightsource Renewable Development Limited,
7th Floor, 33 Holborn, London, EC1N 2HU
General: +44 (0) 333 200 0755
Web: www.lightsourcebp.com
info@lightsourcebp.com

GBR_EPД_Monitoring House/Communication Building_01



THIS DOCUMENT IS THE PROPERTY OF LIGHTSOURCE RENEWABLE DEVELOPMENT LTD
IT IS PROHIBITED TO REPRODUCE IT FOR OTHER PURPOSES WITHOUT AUTHORIZATION IN WRITING

GBR_EPД_Monitoring House/Communication Building_01			
DA			Nov. 2023
DRAWN	CHECKED	APPROVED	DATE
Paper Size: A3	Scale: 1:50	Sheet: 1	
DRAWING NUMBER: GBR_EPД_MH/CB		STATUS: Rev 01	

lightsourcebp  

Lightsource Renewable Development Limited,
7th Floor, 33 Holborn, London, EC1N 2HU
General: +44 (0) 333 200 0755
Web: www.lightsourcebp.com
info@lightsourcebp.com

A3 - (420 x 297)mm

GBR_EPД_Spares 40' Container_00

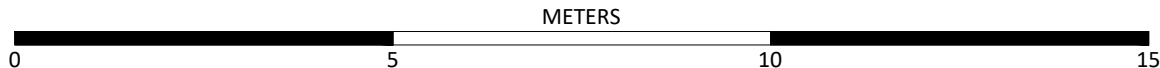
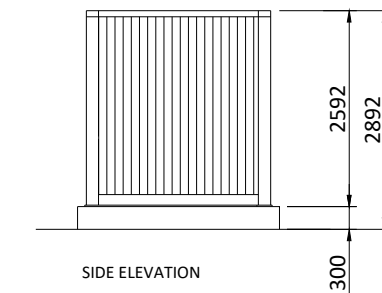
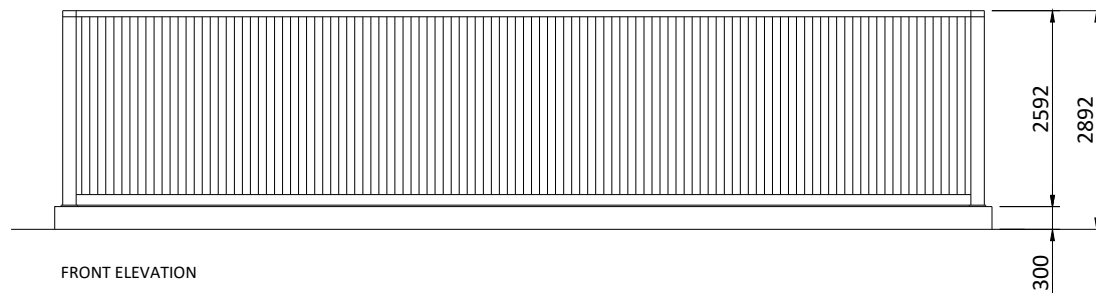
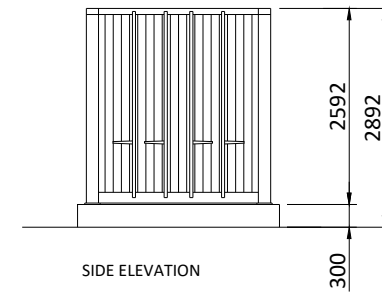
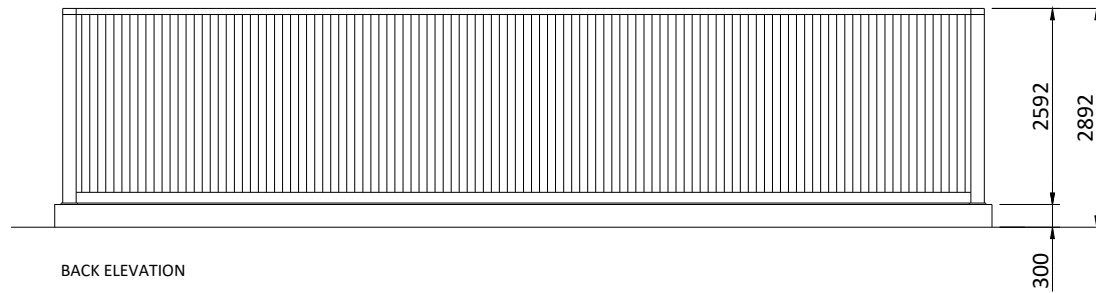
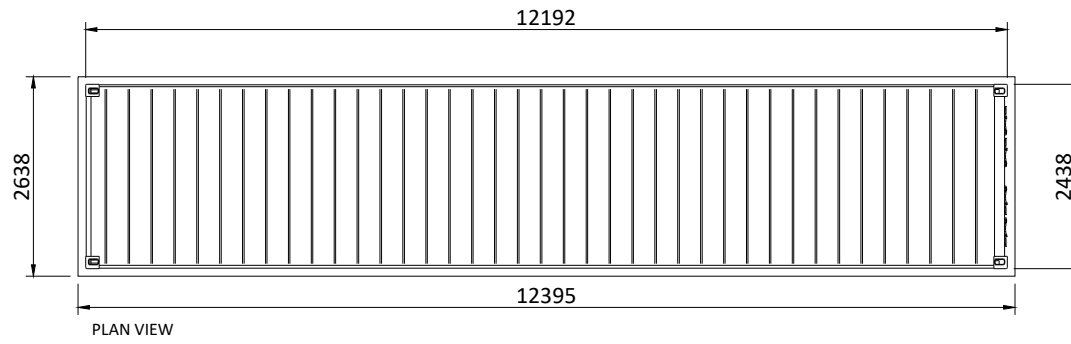

A3 - (420 x 297)mm

THIS DOCUMENT IS THE PROPERTY OF LIGHTSOURCE RENEWABLE DEVELOPMENT LTD
IT IS PROHIBITED TO REPRODUCE IT FOR OTHER PURPOSES WITHOUT AUTHORIZATION IN WRITING

GBR_EPД_Spares 40' Container_01			
DA			Nov. 2023
DRAWN	CHECKED	APPROVED	DATE
Paper Size:	Scale:	Sheet:	
A3	1:100	1	
DRAWING NUMBER:		STATUS:	
GBR_EPД_S40		Rev 01	
Lightsource Renewable Development Limited, 7th Floor, 33 Holborn, London, EC1N 2HU General: +44 (0) 333 200 0755 Web: www.lightsourcebp.com info@lightsourcebp.com			

GBR_Plus Power Solar & Battery Project_Indicative BESS Layout_01



	Site Boundary
	Site Access
	BESS Enclosure x 4
	BIC
	Twin MV Skid
	Backup Generator
	BESS Intake Substation
	Monitoring House
	Spares Container
	Spares Container
	Access Road
	Access Gates
	CCTV
	BESS Lightning
	Attenuation Pond
	Existing Access Road
	Existing Tree

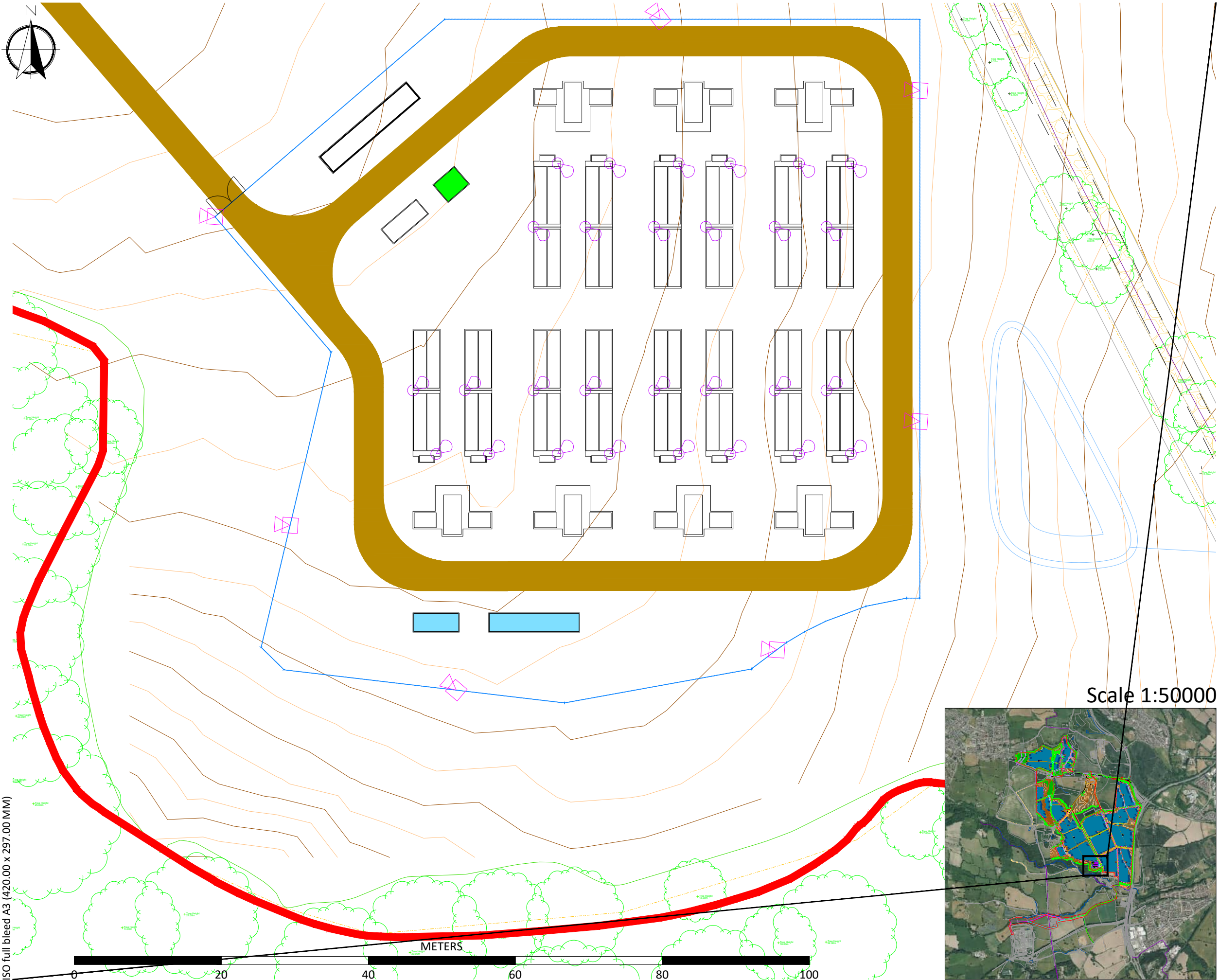

Scale 1:50000

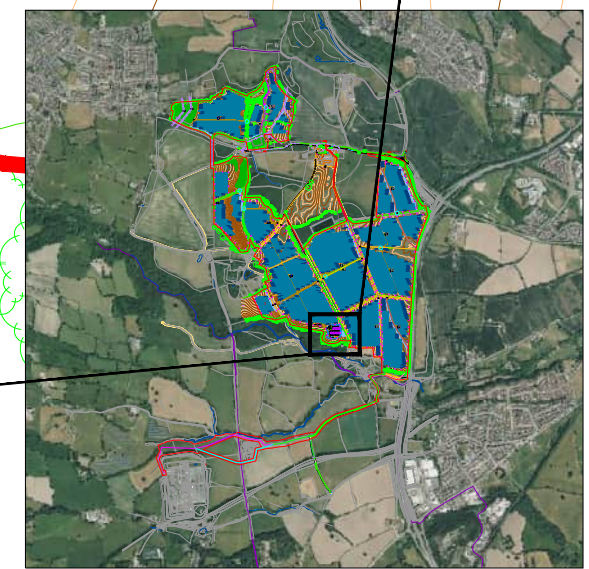

Reproduced from Ordnance Survey digital map data © Crown copyright 2023. All rights reserved. Licence number 0100031673

DA	CHECKED	APPROVED	DATE
			31.01.2024
PROJECT NAME & ADDRESS:			
Location: Plas Power Estate, Rhosrobin			
Postcode: Caego, Wrexham, Wales			
NOTES:			
-			
-			
-			
-			
Paper Size:	Scale:	Sheet:	
A3	1:500	1	
CAPACITY:			
DRAWING TITLE:			
GBR_Plus Power Solar & Battery Project_Indicative BESS Layout_01			
DRAWING NUMBER:		STATUS:	
BESS_LYT		Pre-application Consultation	
Lightsource Renewable Development Limited, 7th Floor, 33 Holborn, London, EC1N 2HU General: +44 (0) 333 200 0755 Web: www.lightsourcebp.com info@lightsourcebp.com			

ISO full bleed A3 (420.00 x 297.00 MM)

THIS DOCUMENT IS THE PROPERTY OF LIGHTSOURCE RENEWABLE DEVELOPMENT LTD
IT IS PROHIBITED TO REPRODUCE IT FOR OTHER PURPOSES WITHOUT AUTHORIZATION IN WRITING

GBR_EPД_BESS Enclosures_00

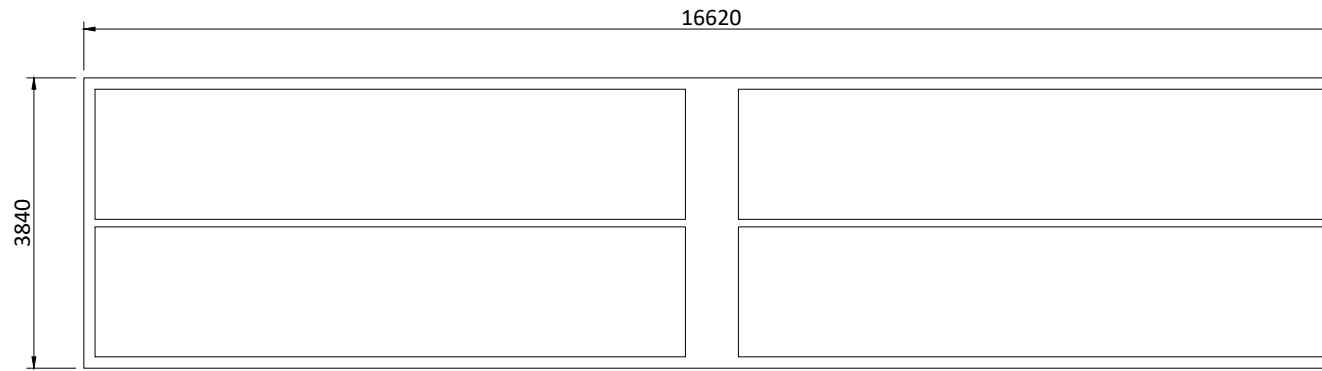

PLAN VIEW

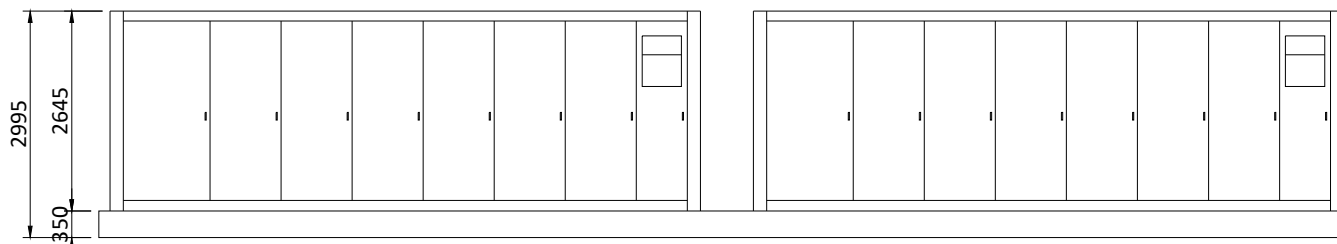

FRONT ELEVATION

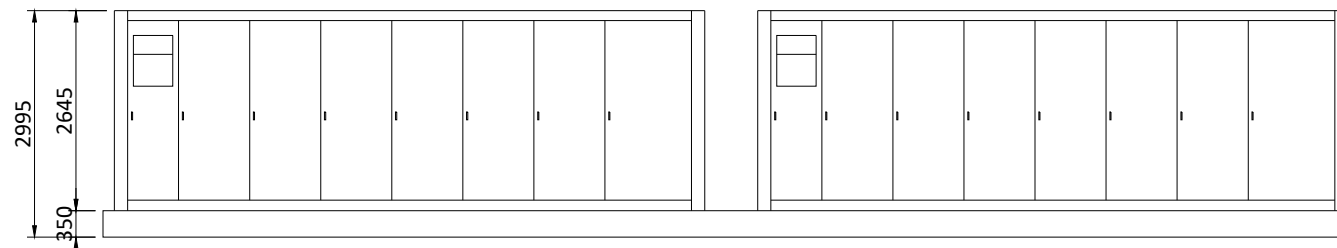

BACK ELEVATION

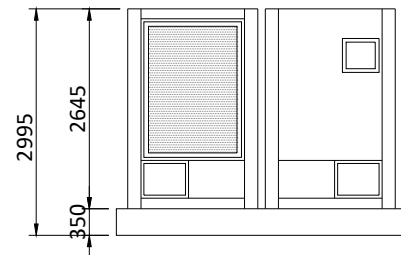

SIDE ELEVATION

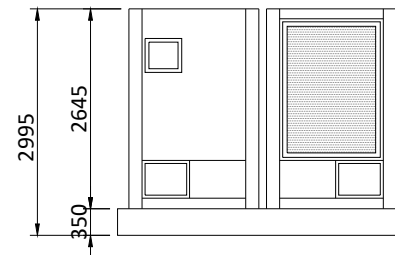

SIDE ELEVATION

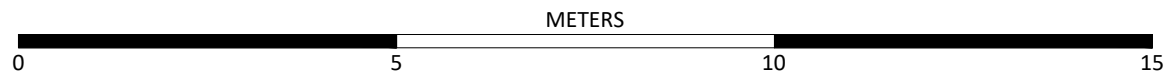

A3 - (420 x 297)mm

THIS DOCUMENT IS THE PROPERTY OF LIGHTSOURCE RENEWABLE DEVELOPMENT LTD
IT IS PROHIBITED TO REPRODUCE IT FOR OTHER PURPOSES WITHOUT AUTHORIZATION IN WRITING

UK_EPД_BESS Enclosures_00			
DA			Nov. 2023
DRAWN	CHECKED	APPROVED	DATE
Paper Size: A3	Scale: 1:100	Sheet: 1	
DRAWING NUMBER: UK_EPД_BSS		STATUS: Rev 01	

lightsource bp 

lightsource Renewable Development Limited,
7th Floor, 33 Holborn, London, EC1N 2HU
General: +44 (0) 333 200 0755
Web: www.lightsourcebp.com
info@lightsourcebp.com

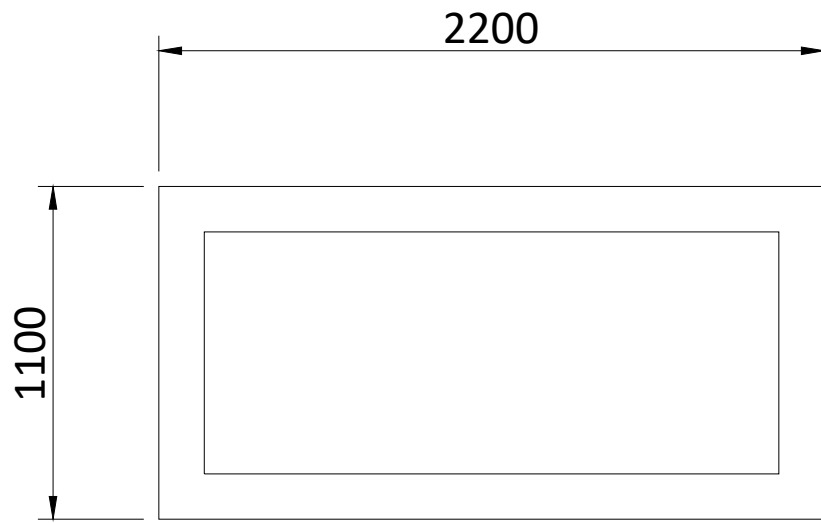

FLOOR PLAN

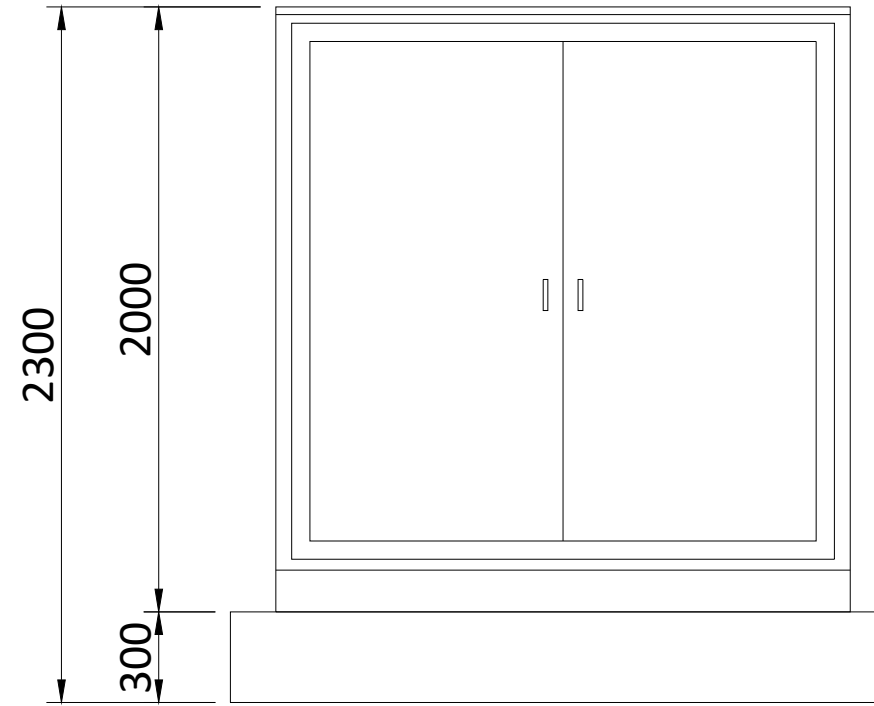

FRONT ELEVATION

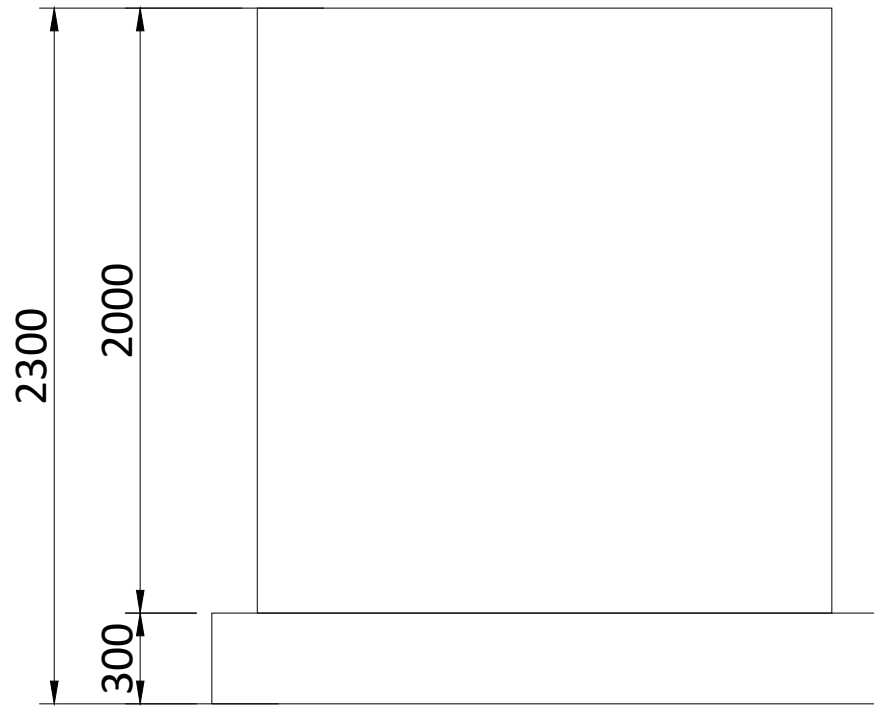

BACK ELEVATION

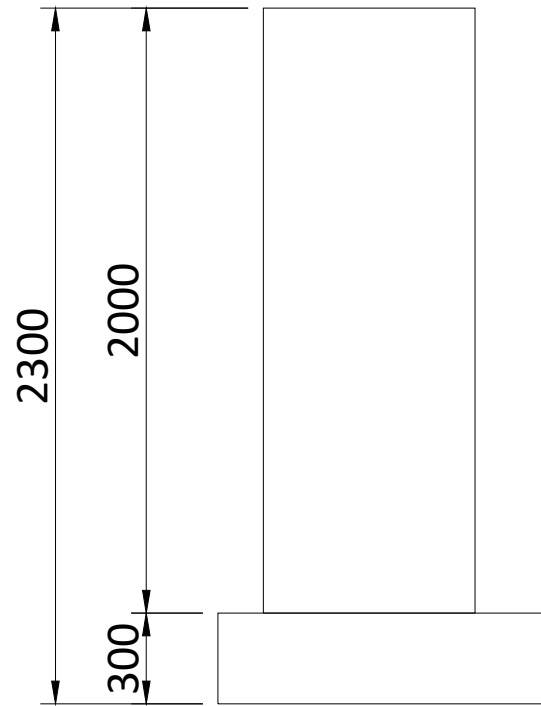

LEFT SIDE ELEVATION

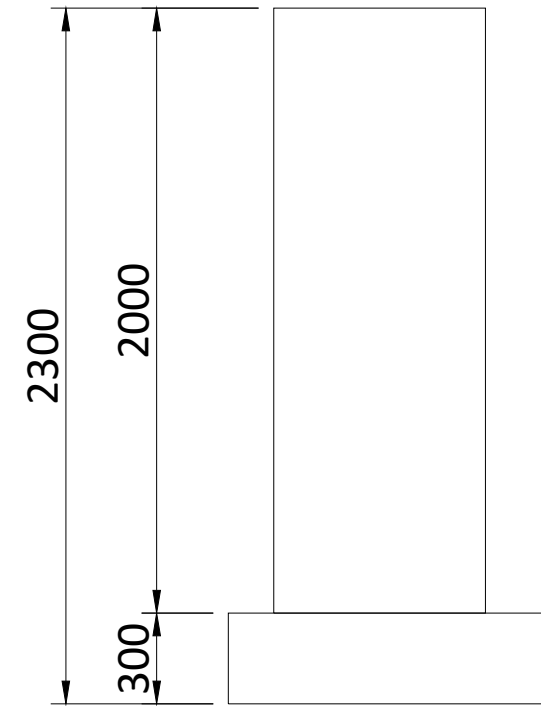

RIGHT SIDE ELEVATION

METERS



A3 - (420 x 297)mm

THIS DOCUMENT IS THE PROPERTY OF LIGHTSOURCE RENEWABLE DEVELOPMENT LTD
IT IS PROHIBITED TO REPRODUCE IT FOR OTHER PURPOSES WITHOUT AUTHORIZATION IN WRITING

GBR_EPД_BIC_00			
DA			Nov. 2023
DRAWN	CHECKED	APPROVED	DATE
Paper Size: A3	Scale: 1:25	Sheet: 1	
DRAWING NUMBER: GBR_EPД_BIC		STATUS: Rev 01	

lightsource bp 

Lightsource Renewable Development Limited,
7th Floor, 33 Holborn, London, EC1N 2HU
General: +44 (0) 333 200 0755
Web: www.lightsourcebp.com
info@lightsourcebp.com

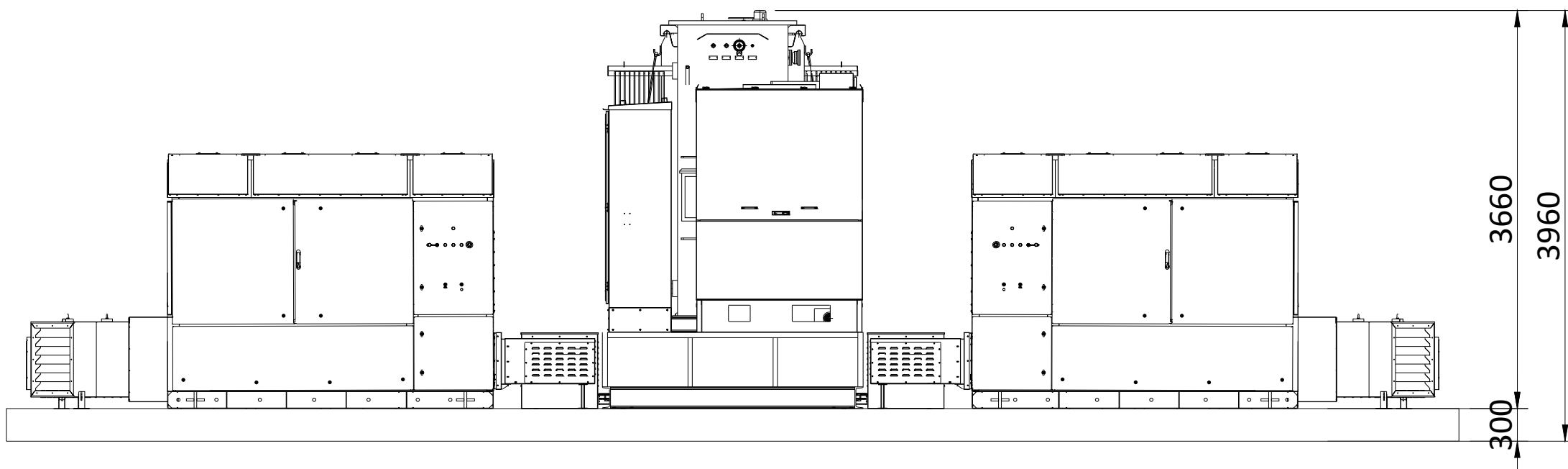

FRONT ELEVATION

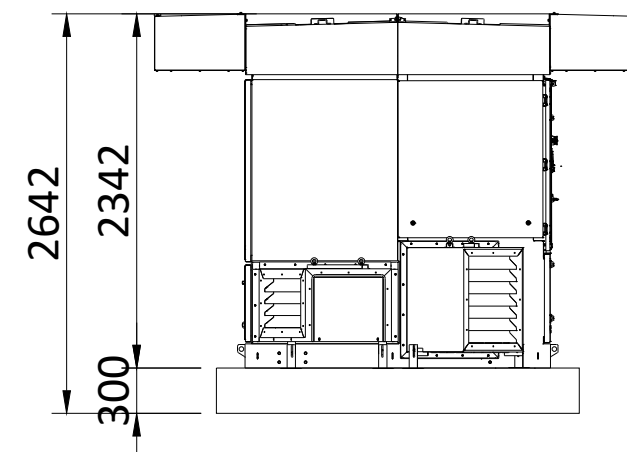

SIDE ELEVATION

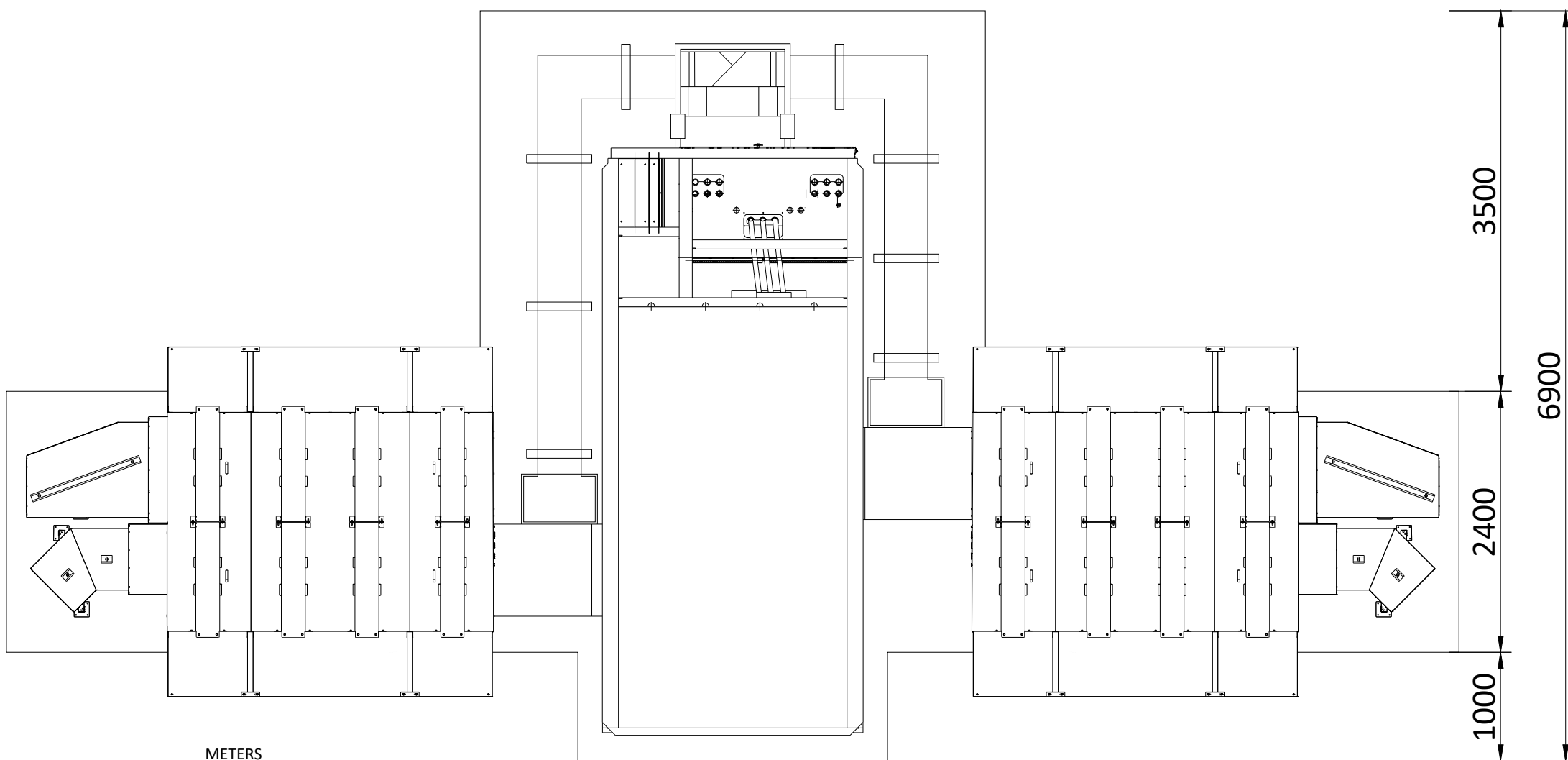
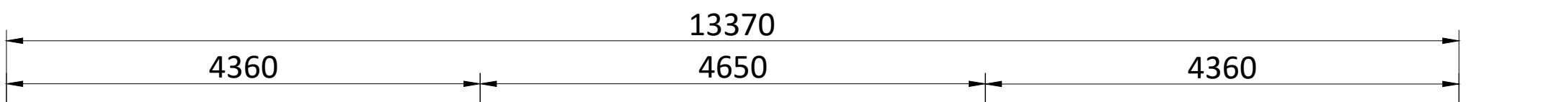



PLAN VIEW

A3 - (420 x 297)mm



THIS DOCUMENT IS THE PROPERTY OF LIGHTSOURCE RENEWABLE DEVELOPMENT LTD. IT IS PROHIBITED TO REPRODUCE IT FOR OTHER PURPOSES WITHOUT AUTHORIZATION IN WRITING

GBR_EPД_Twin MV Skid-NR_00			
EXC			02.02.2024
DRAWN	CHECKED	APPROVED	DATE
Paper Size: A3	Scale: 1:50	Sheet: 1	
DRAWING NUMBER: UK_EPД_TWS-NR		STATUS: Preliminary	
 			
Lightsource Renewable Development Limited, 7th Floor, 33 Holborn, London, EC1N 2HU General: +44 (0) 333 200 0755 Web: www.lightsourcebp.com info@lightsourcebp.com			

GBR_EPД_Backup Generator 20_00

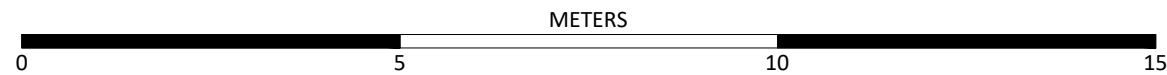
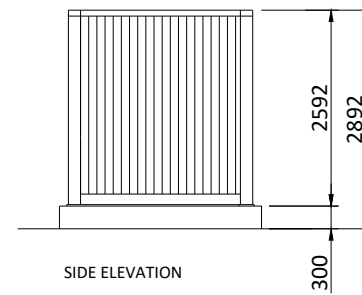
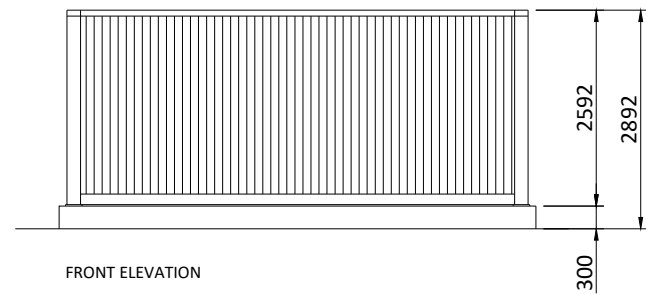
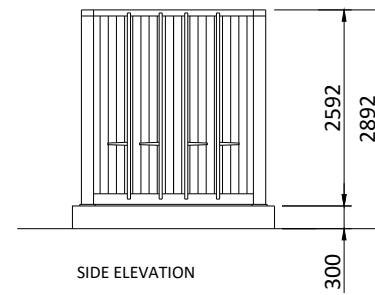
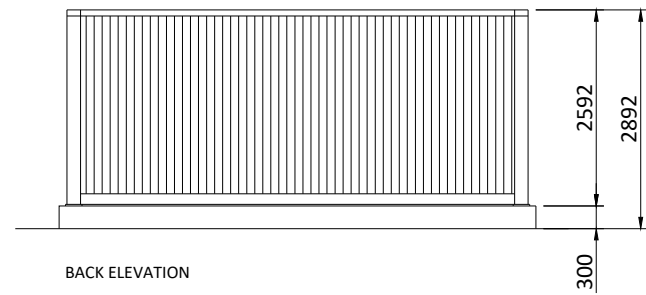
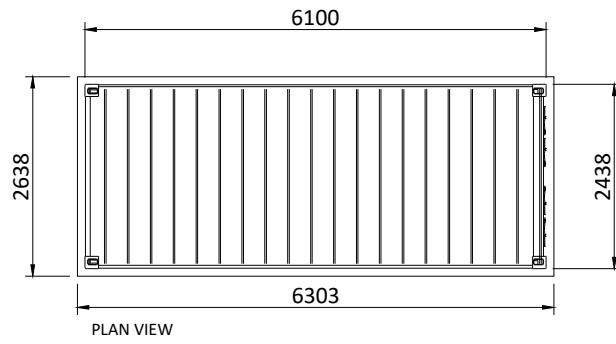

A3 - (420 x 297)mm

THIS DOCUMENT IS THE PROPERTY OF LIGHTSOURCE RENEWABLE DEVELOPMENT LTD
IT IS PROHIBITED TO REPRODUCE IT FOR OTHER PURPOSES WITHOUT AUTHORIZATION IN WRITING

GBR_EPД_Backup Generator 20_00			
DA			Nov. 2023
DRAWN	CHECKED	APPROVED	DATE
Paper Size: A3	Scale: 1:100	Sheet: 1	
DRAWING NUMBER: GBR_EPД_G20		STATUS: Rev 01	



 Lightsource Renewable Development Limited,
 7th Floor, 33 Holborn, London, EC1N 2HU
 General: +44 (0) 333 200 0755
 Web: www.lightsourcebp.com
 info@lightsourcebp.com

GBR_EPД_Spares 20' Container_01

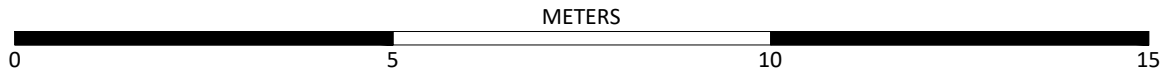
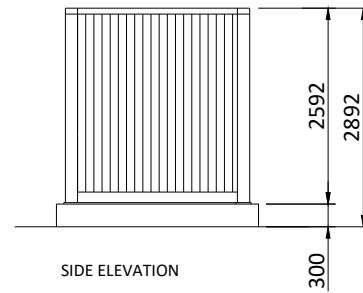
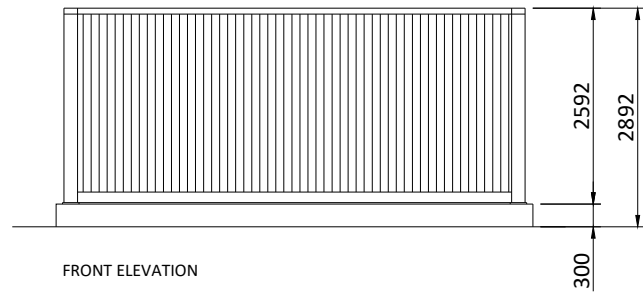
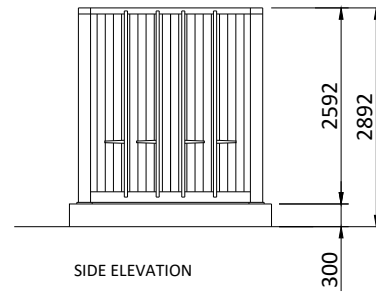
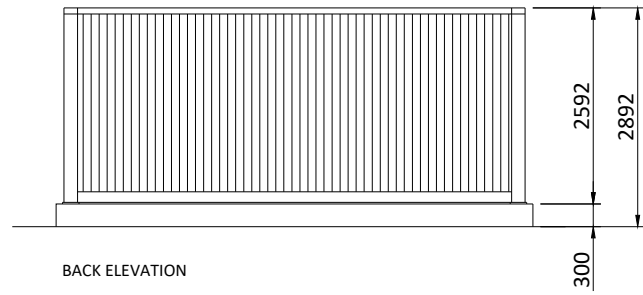
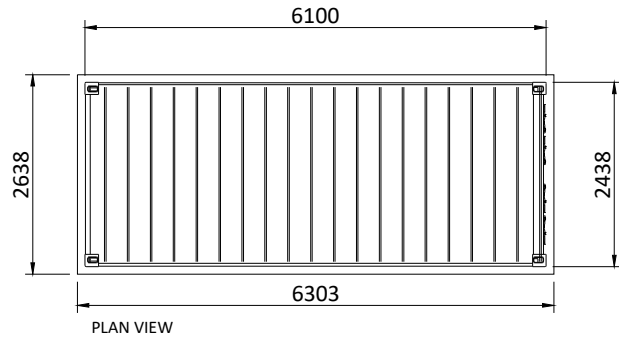

A3 - (420 x 297)mm

THIS DOCUMENT IS THE PROPERTY OF LIGHTSOURCE RENEWABLE DEVELOPMENT LTD
IT IS PROHIBITED TO REPRODUCE IT FOR OTHER PURPOSES WITHOUT AUTHORIZATION IN WRITING

GBR_EPД_Spares 20' Container_01			
DA			Nov. 2023
DRAWN	CHECKED	APPROVED	DATE
Paper Size: A3	Scale: 1:100	Sheet: 1	
DRAWING NUMBER: GBR_EPД_S20		STATUS: Rev 01	



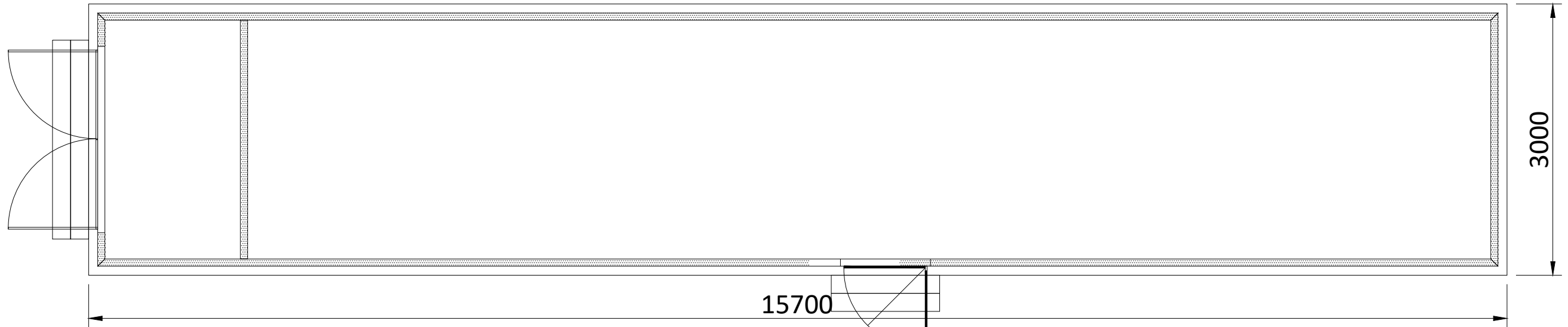

Lightsource Renewable Development Limited,
 7th Floor, 33 Holborn, London, EC1N 2HU
 General: +44 (0) 333 200 0755
 Web: www.lightsourcebp.com
 info@lightsourcebp.com

GBR_EPД_BESS Intake Substation_00

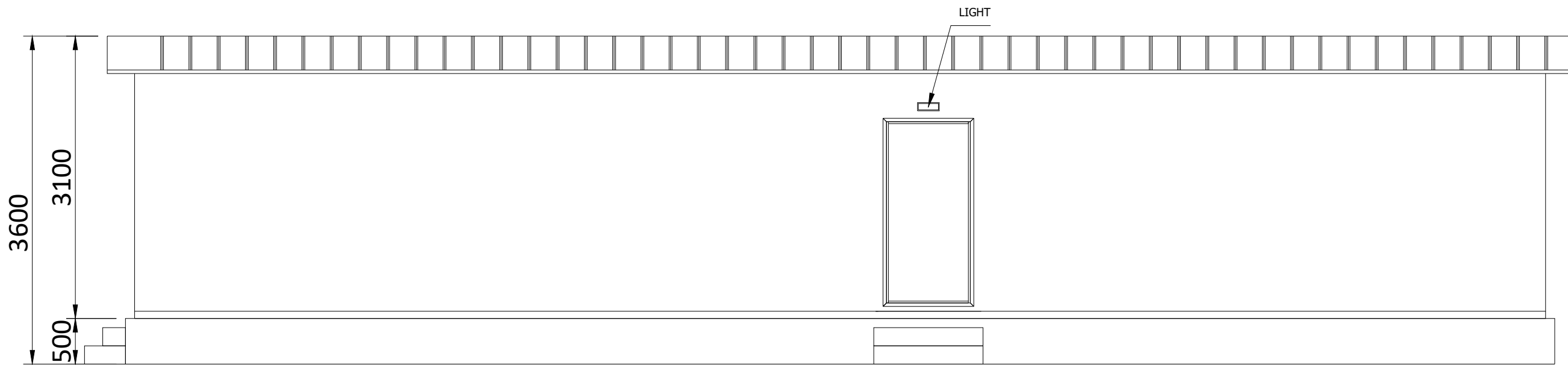

FLOOR PLAN



FRONT ELEVATION

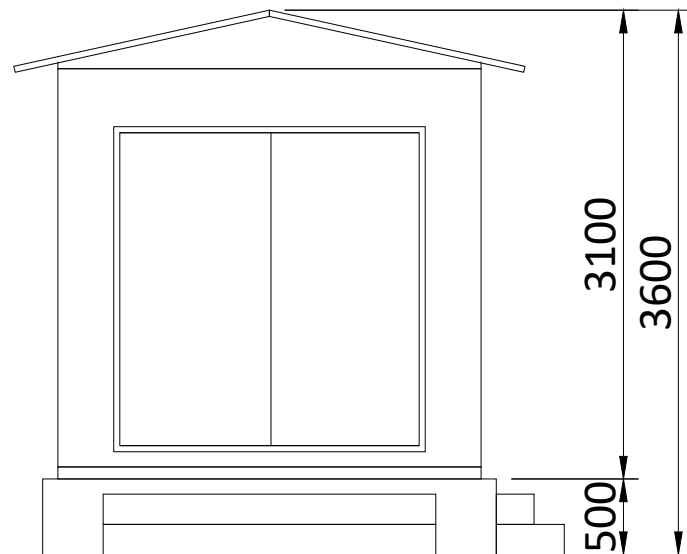

SIDE ELEVATION

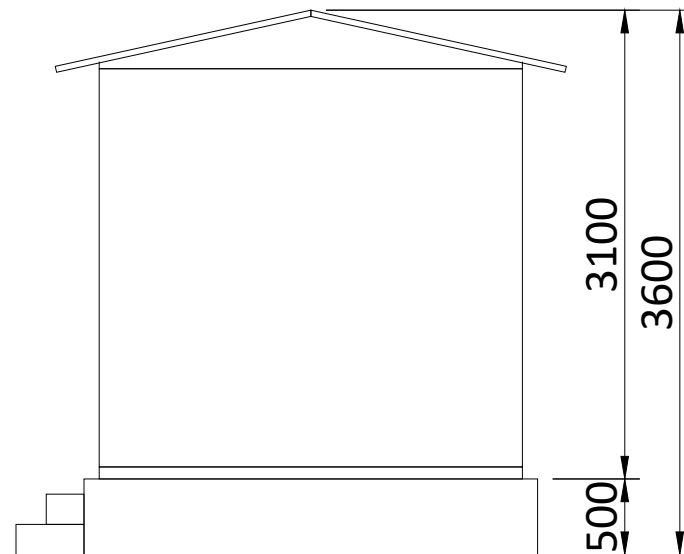

SIDE ELEVATION



METERS

THIS DOCUMENT IS THE PROPERTY OF LIGHTSOURCE RENEWABLE DEVELOPMENT LTD
IT IS PROHIBITED TO REPRODUCE IT FOR OTHER PURPOSES WITHOUT AUTHORIZATION IN WRITING

GBR_EPД_BESS Intake Substation_00			
DA			Nov. 2023
DRAWN	CHECKED	APPROVED	DATE
Paper Size: A3	Scale: 1:50	Sheet: 1	
DRAWING NUMBER: GBR_EPД_BIS		STATUS: Rev 01	





Lightsource Renewable Development Limited,
 7th Floor, 33 Holborn, London, EC1N 2HU
 General: +44 (0) 333 200 0755
 Web: www.lightsourcebp.com
 info@lightsourcebp.com

A3 - (420 x 297)mm

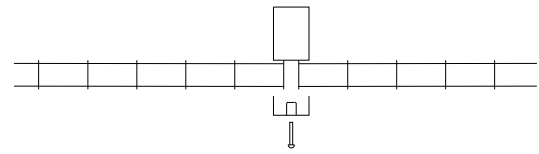

GBR_EPД_BESS Security Fence_02

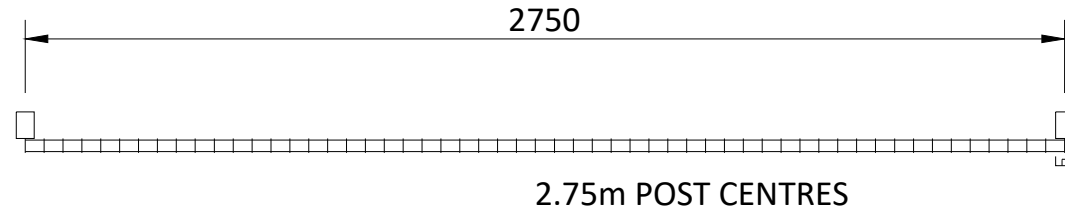

IN-LINE PLAN
(1:10)



2750
2.75m POST CENTRES

-  POST PLAN
-  47 X 25MM CLIP
-  M8 X 40mm
STAINLESS STEEL
PIN HEX
DOME-HEAD
SECURITY SCREWS

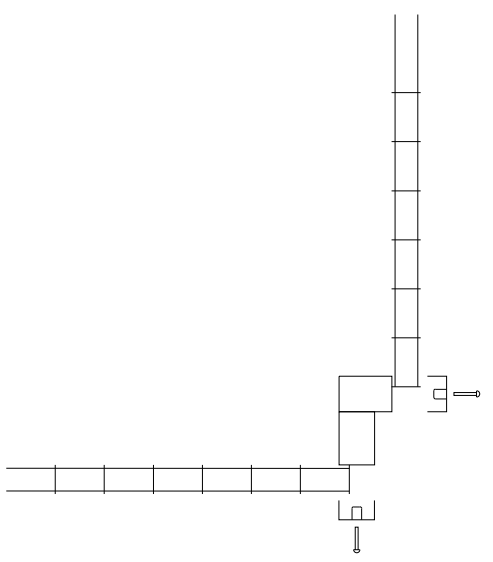

CORNER PLAN
(1:10)



50

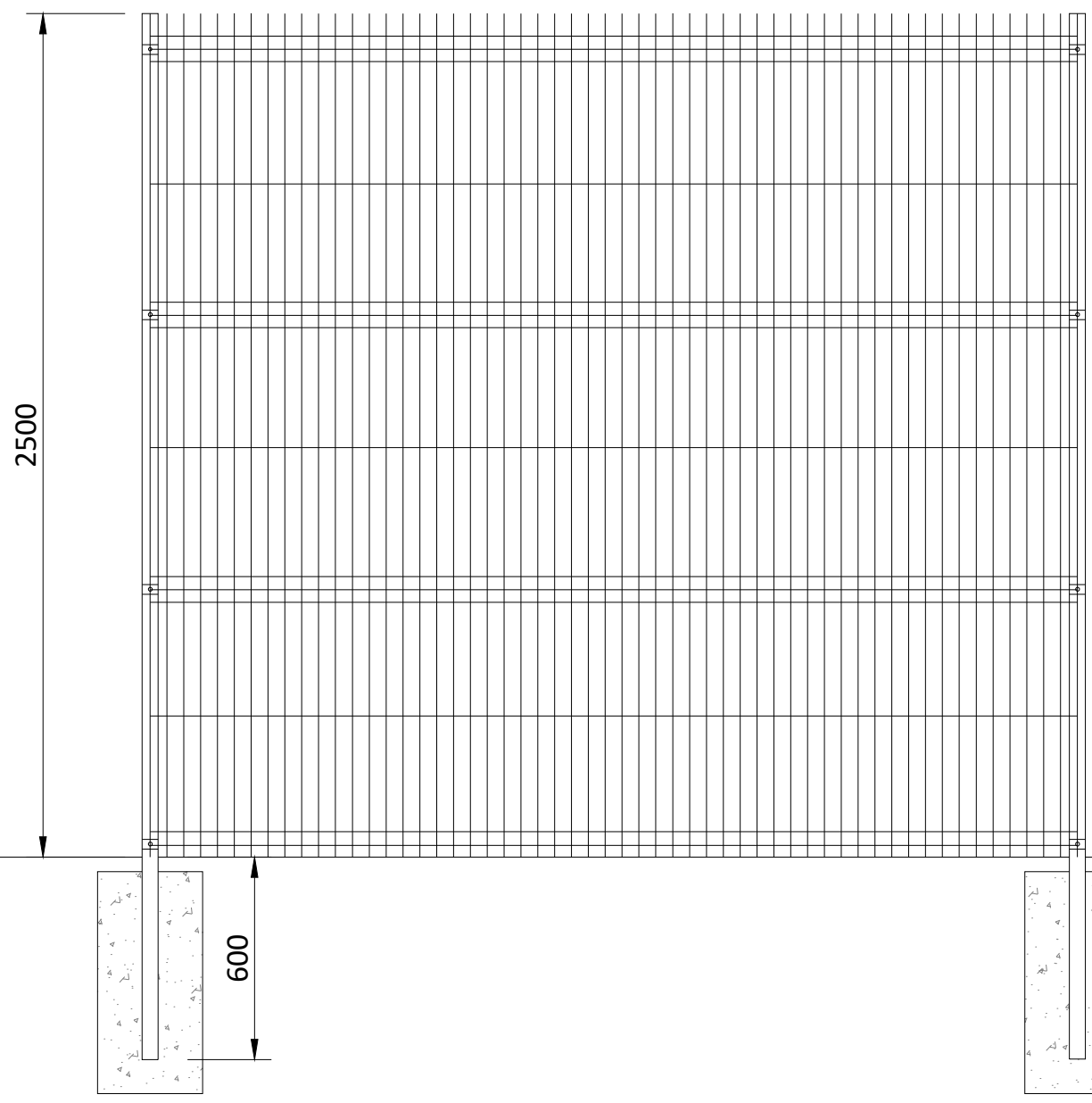

2500

600

SECURITY FENCING ELEVATIONS

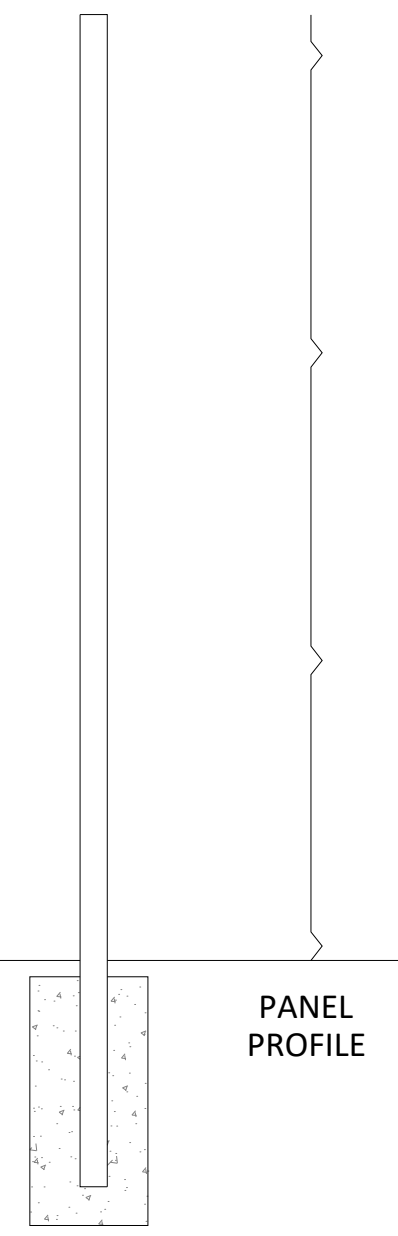

PANEL PROFILE

POST PROFILE

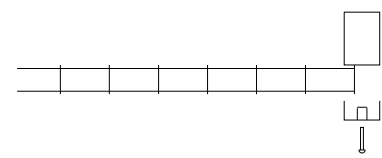

END PLAN
(1:10)

METERS



A3 - (420 x 297)mm

THIS DOCUMENT IS THE PROPERTY OF LIGHTSOURCE RENEWABLE DEVELOPMENT LTD. IT IS PROHIBITED TO REPRODUCE IT FOR OTHER PURPOSES WITHOUT AUTHORIZATION IN WRITING.

GBR_EPД_BESS Security Fence_02			
DA			Nov. 2023
DRAWN	CHECKED	APPROVED	DATE
Paper Size: A3	Scale: 1:20	Sheet: 1	
DRAWING NUMBER: GBR_EPД_BSF		STATUS: Rev 01	
			
Lightsource Renewable Development Limited, 7th Floor, 33 Holborn, London, EC1N 2HU General: +44 (0) 333 200 0755 Web: www.lightsourcebp.com info@lightsourcebp.com			

GBR_EPД_BESS CCTV_00

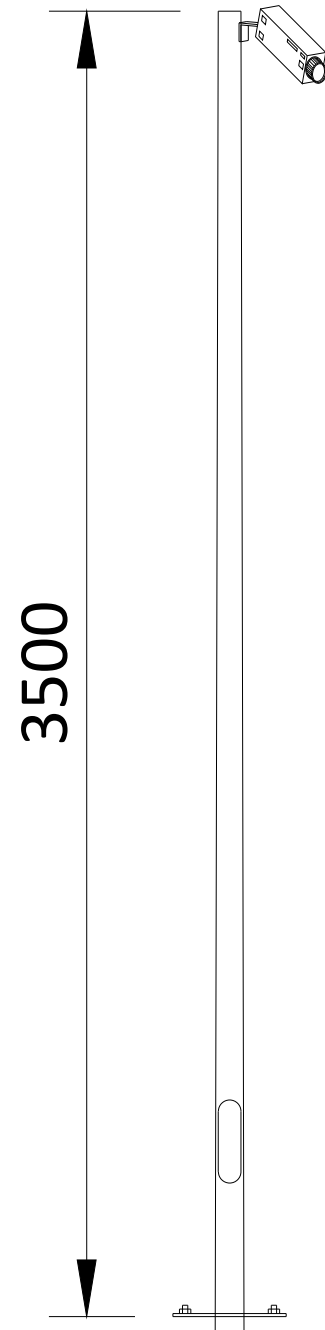



METERS



A3 - (420 x 297)mm

THIS DOCUMENT IS THE PROPERTY OF LIGHTSOURCE RENEWABLE DEVELOPMENT LTD
IT IS PROHIBITED TO REPRODUCE IT FOR OTHER PURPOSES WITHOUT AUTHORIZATION IN WRITING

GBR_EPД_BESS CCTV_00			
DA			Nov. 2023
DRAWN	CHECKED	APPROVED	DATE
A3	Scale: 1:20	Sheet: 1	
DRAWING NUMBER: GBR_EPД_BCC		STATUS: Rev 01	

lightsourcebp  

Lightsource Renewable Development Limited,
7th Floor, 33 Holborn, London, EC1N 2HU
General: +44 (0) 333 200 0755
Web: www.lightsourcebp.com
info@lightsourcebp.com

UK_EPD_BESS Gate_02

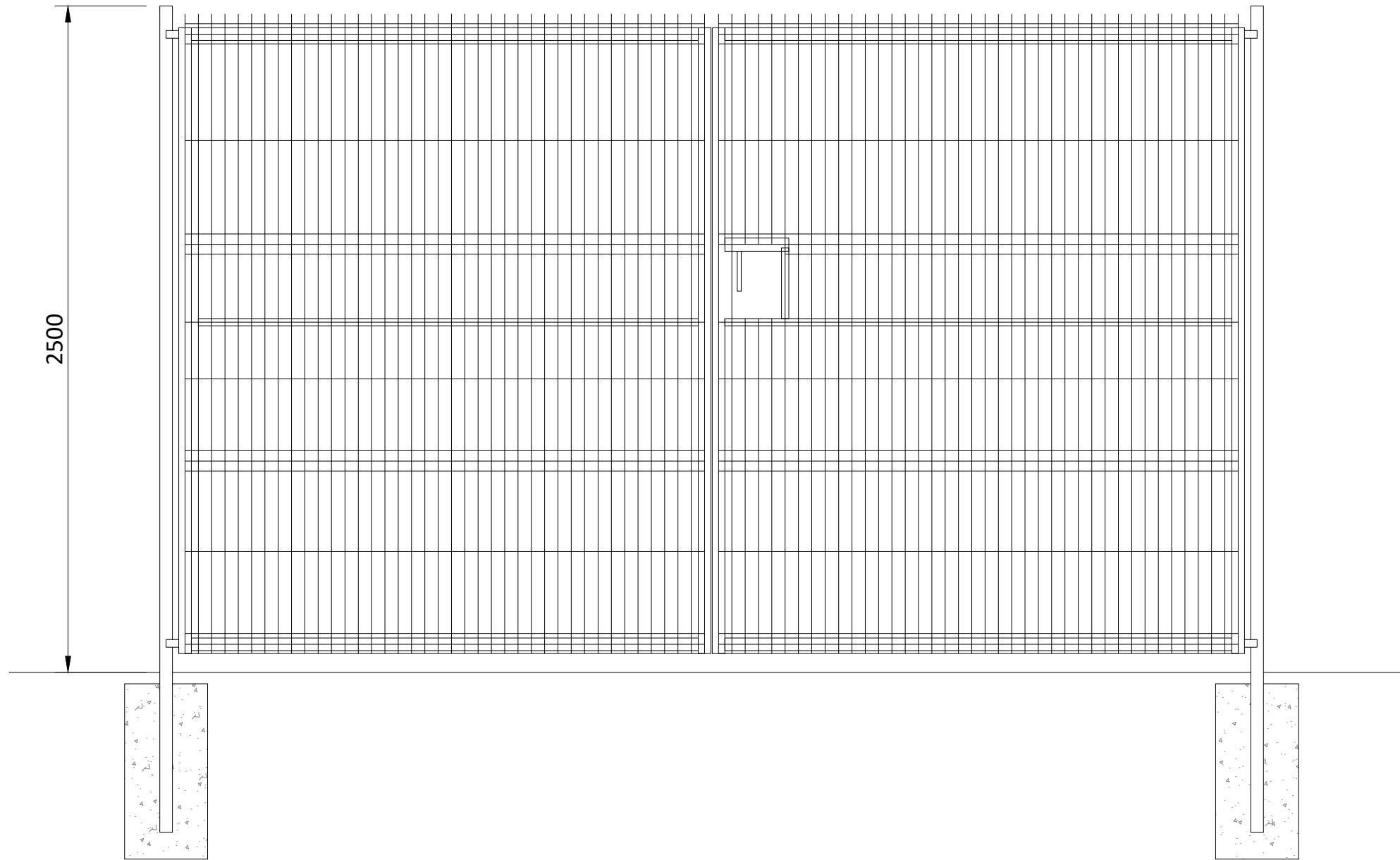

SECURITY GATE ELEVATION

METERS



A3 - (420 x 297)mm

THIS DOCUMENT IS THE PROPERTY OF LIGHTSOURCE RENEWABLE DEVELOPMENT LTD
IT IS PROHIBITED TO REPRODUCE IT FOR OTHER PURPOSES WITHOUT AUTHORIZATION IN WRITING

GBR_EPD_BESS Gate_02			
DA			Nov. 2023
DRAWN	CHECKED	APPROVED	DATE
Paper Size:	Scale:	Sheet:	
A3	1:20	1	
DRAWING NUMBER:		STATUS:	
GBR_EPD_BSG		Rev 01	
Lightsource Renewable Development Limited, 7th Floor, 33 Holborn, London, EC1N 2HU General: +44 (0) 333 200 0755 Web: www.lightsourcebp.com info@lightsourcebp.com			

GBR_EPD_BESS Lightning_00

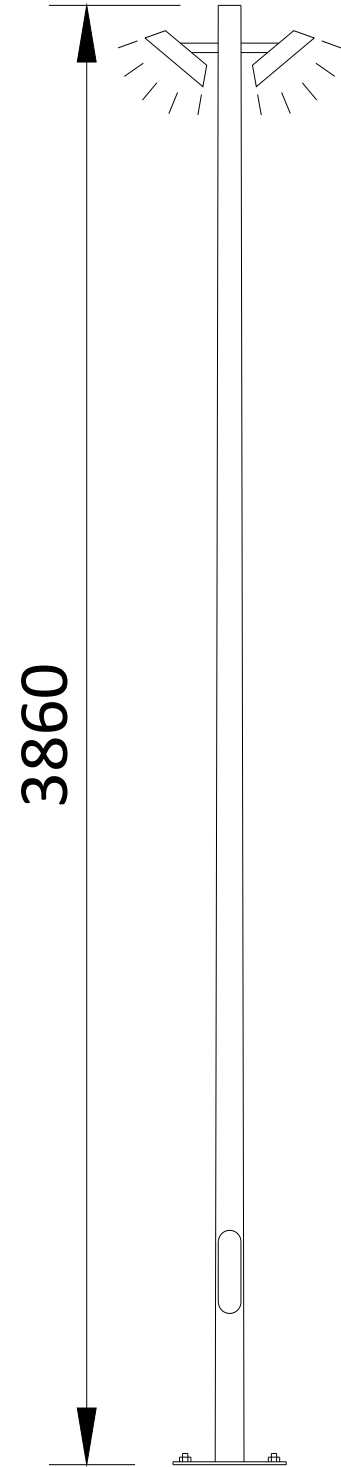

3860

METERS



A3 - (420 x 297)mm

THIS DOCUMENT IS THE PROPERTY OF LIGHTSOURCE RENEWABLE DEVELOPMENT LTD. IT IS PROHIBITED TO REPRODUCE IT FOR OTHER PURPOSES WITHOUT AUTHORIZATION IN WRITING.

GBR_EPD_BESS Lightning_00			
DA			Nov. 2023
DRAWN	CHECKED	APPROVED	DATE
Paper Size: A3	Scale: 1:20	Sheet: 1	
DRAWING NUMBER: GBR_EPD_BLG		STATUS: Rev 01	
Lightsource Renewable Development Limited, 7th Floor, 33 Holborn, London, EC1N 2HU General: +44 (0) 333 200 0755 Web: www.lightsourcebp.com info@lightsourcebp.com			

GBR_EPD_Security Fence_01

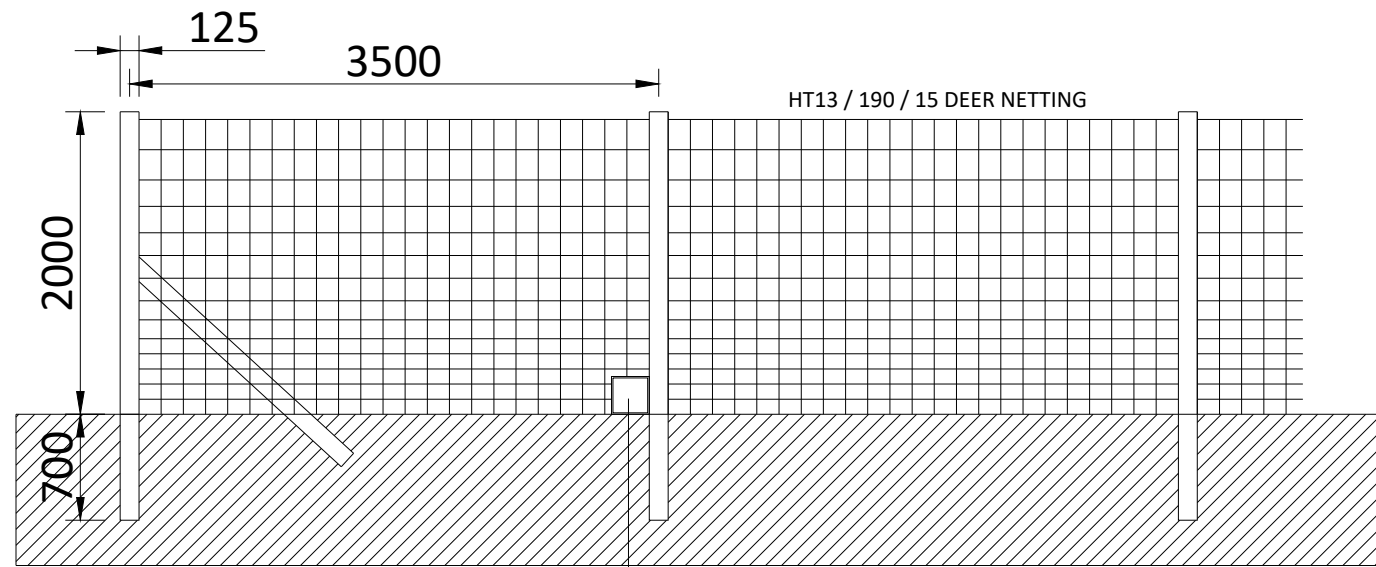

Small Mammal gates fitted at appropriate points to enable free access 250mm x 250mm

NOTES:
Deer Fence Mesh dimensions are 150mm x 150mm



A3 - (420 x 297)mm

THIS DOCUMENT IS THE PROPERTY OF LIGHTSOURCE RENEWABLE DEVELOPMENT LTD
IT IS PROHIBITED TO REPRODUCE IT FOR OTHER PURPOSES WITHOUT AUTHORIZATION IN WRITING

GBR_EPD_Security Fence_01			
DA			Nov. 2023
DRAWN	CHECKED	APPROVED	DATE
Paper Size:	Scale:	Sheet:	
A3	1:50	1	
DRAWING NUMBER:		STATUS:	
GBR_EPD_FNC		Rev 01	
Lightsource Renewable Development Limited, 7th Floor, 33 Holborn, London, EC1N 2HU General: +44 (0) 333 200 0755 Web: www.lightsourcebp.com info@lightsourcebp.com			

GBR_EPД_Gate_01

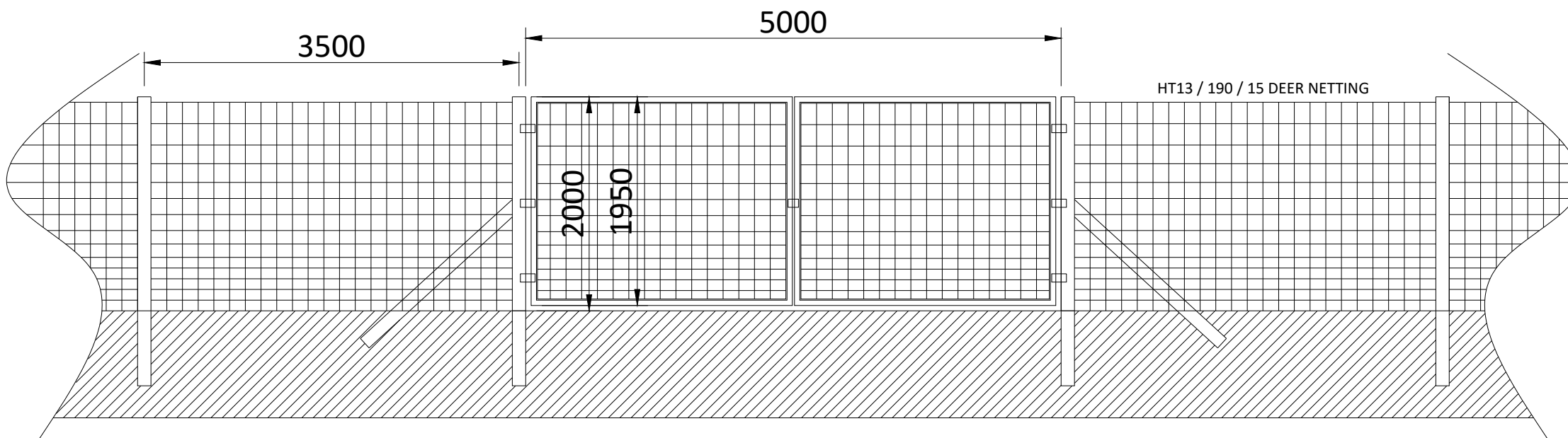

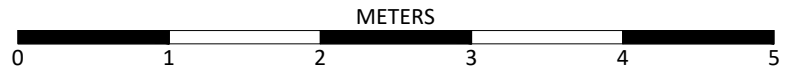

A3 - (420 x 297)mm



THIS DOCUMENT IS THE PROPERTY OF LIGHTSOURCE RENEWABLE DEVELOPMENT LTD
IT IS PROHIBITED TO REPRODUCE IT FOR OTHER PURPOSES WITHOUT AUTHORIZATION IN WRITING

GBR_EPД_Gate_01			
DA			Nov. 2023
DRAWN	CHECKED	APPROVED	DATE
Paper Size: A3	Scale: 1:50	Sheet: 1	
DRAWING NUMBER: GBR_EPД_GTD		STATUS: Rev 01	



Lightsource Renewable Development Limited,
 7th Floor, 33 Holborn, London, EC1N 2HU
 General: +44 (0) 333 200 0755
 Web: www.lightsourcebp.com
 info@lightsourcebp.com

GBR_EPД_PV CCTV_01

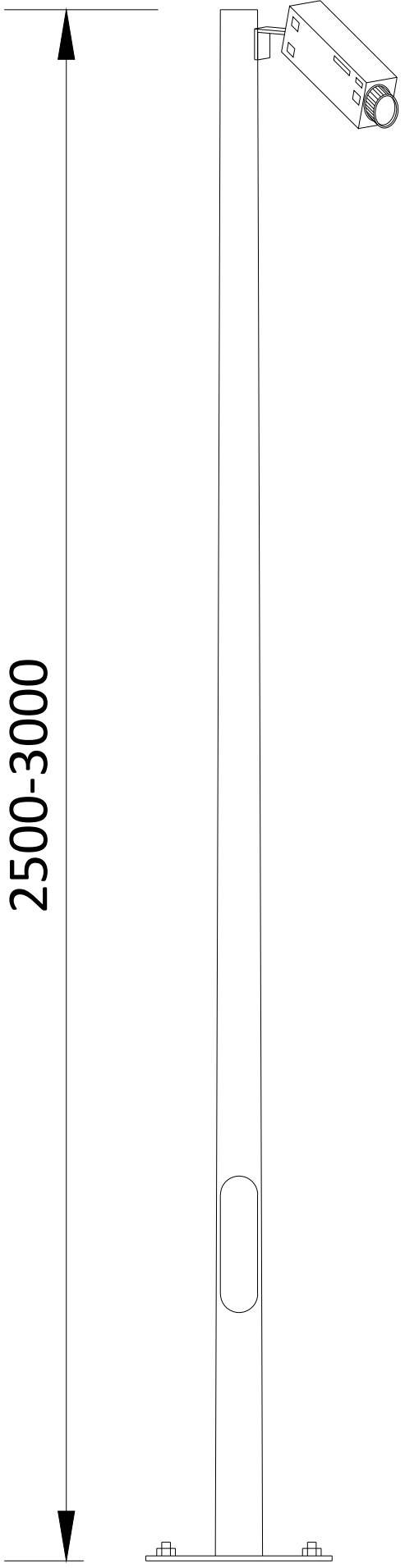

A3 - (420 x 297)mm

THIS DOCUMENT IS THE PROPERTY OF LIGHTSOURCE RENEWABLE DEVELOPMENT LTD
IT IS PROHIBITED TO REPRODUCE IT FOR OTHER PURPOSES WITHOUT AUTHORIZATION IN WRITING

GBR_EPД_PV CCTV_01			
DA			Nov. 2023
DRAWN	CHECKED	APPROVED	DATE
Paper Size: A3	Scale: 1:10	Sheet: 1	
DRAWING NUMBER: GBR_EPД_CTV		STATUS: Rev 01	
 			
Lightsource Renewable Development Limited, 7th Floor, 33 Holborn, London, EC1N 2HU General: +44 (0) 333 200 0755 Web: www.lightsourcebp.com info@lightsourcebp.com			

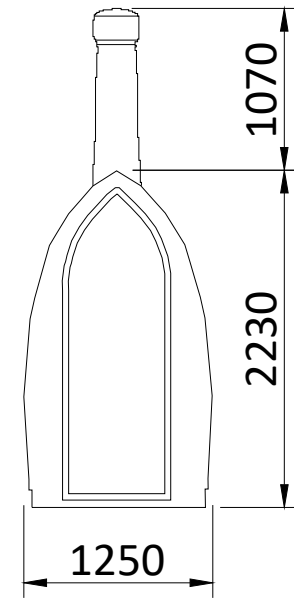

FRONT ELEVATION

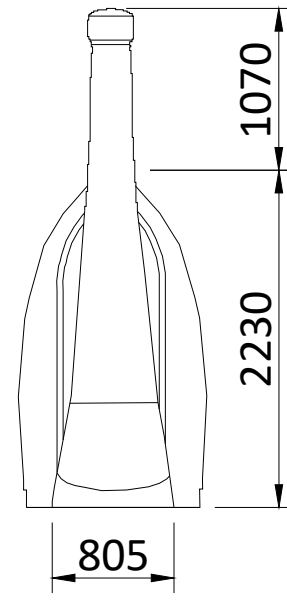

BACK ELEVATION

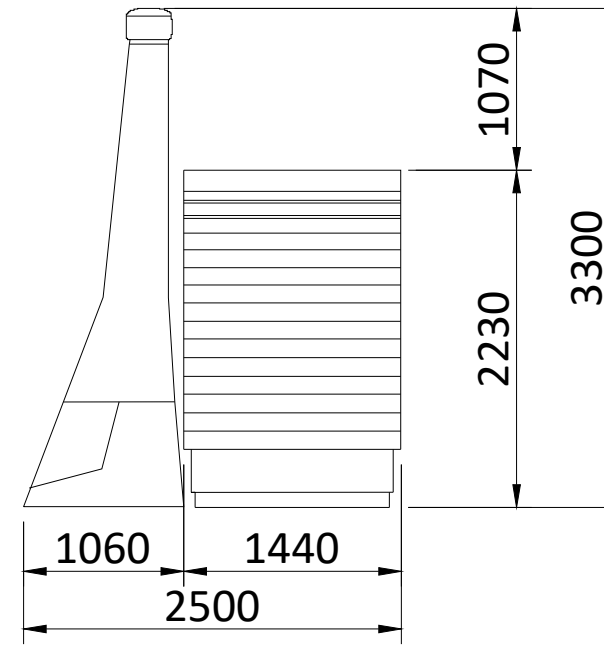

SIDE ELEVATION

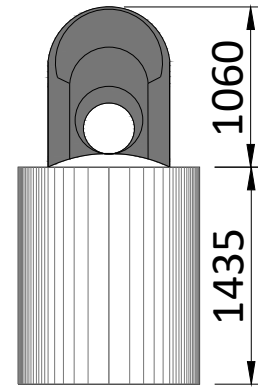

FLOOR PLAN

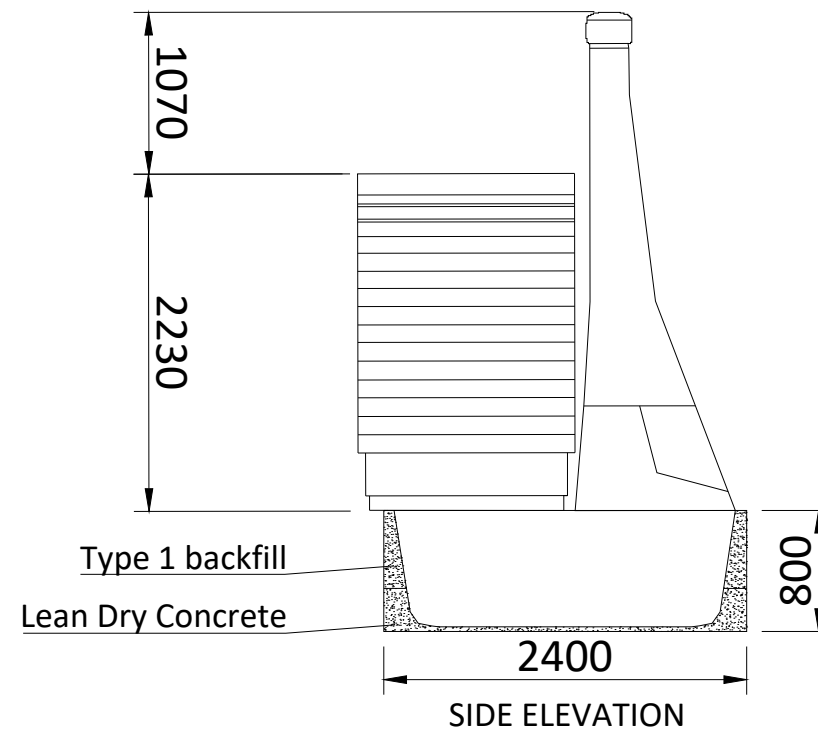



SIDE ELEVATION



METERS

THIS DOCUMENT IS THE PROPERTY OF LIGHTSOURCE RENEWABLE DEVELOPMENT LTD
IT IS PROHIBITED TO REPRODUCE IT FOR OTHER PURPOSES WITHOUT AUTHORIZATION IN WRITING

GBR_EP_D_Toilet_01			
DA			Nov. 2023
DRAWN	CHECKED	APPROVED	DATE
Paper Size: A3	Scale: 1:50	Sheet: 1	
DRAWING NUMBER: GBR_EP_D_TLT		STATUS: Rev 01	

Lightsource Renewable Development Limited,
 7th Floor, 33 Holborn, London, EC1N 2HU
 General: +44 (0) 333 200 0755
 Web: www.lightsourcebp.com
 info@lightsourcebp.com

Access Track Detail

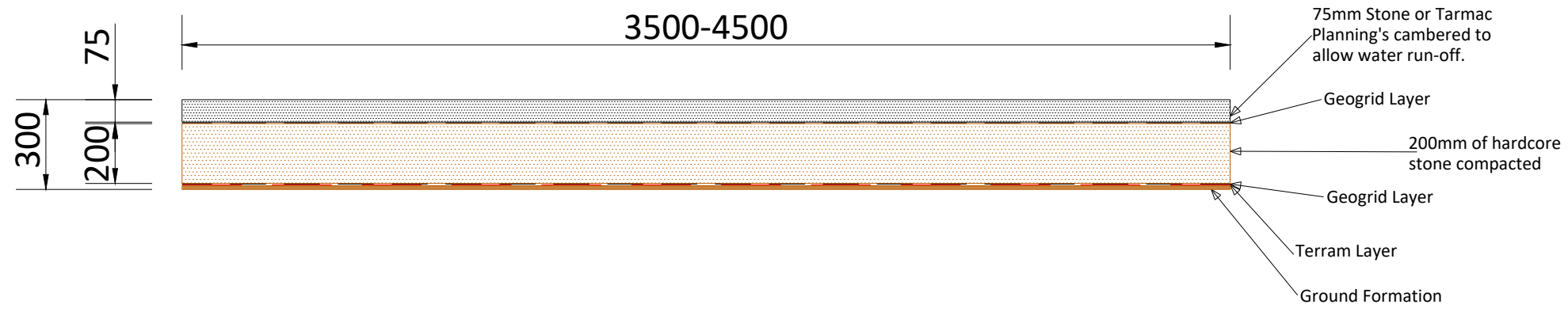

METERS



A3 - (420 x 297)mm

THIS DOCUMENT IS THE PROPERTY OF LIGHTSOURCE RENEWABLE DEVELOPMENT LTD
IT IS PROHIBITED TO REPRODUCE IT FOR OTHER PURPOSES WITHOUT AUTHORIZATION IN WRITING

GBR_EPD_Indicative Road Cross Section_01			
DA			Nov. 2023
DRAWN	CHECKED	APPROVED	DATE
Paper Size:	Scale:	Sheet:	
A3	1:20	1	
DRAWING NUMBER:		STATUS:	
GBR_EPD_RCS		Rev 01	
Lightsource Renewable Development Limited, 7th Floor, 33 Holborn, London, EC1N 2HU General: +44 (0) 333 200 0755 Web: www.lightsourcebp.com info@lightsourcebp.com			